

**25**  
ANNIVERSARY  
YEARS  
ANNIVERSARY

**BORN  
TO BE  
MOTO**

2 0 2 2

 **LightTech**  
italian racing components

**BORN  
TO BE  
MOTO**

**2 0 2 2**

CATALOGUE - KATALOG

made in Italy 

## COMMANDES RÉCULÉES FUSSRASTENANLAGEN

---

- A 12 réglable / Fussrastenanlage
- A 56 accessoires arrières / Ersatzteile
- A 64 repose pied / Rasten

## TENDEUR DE CHÂÎNE KETTENSANNER

---

- A 68 tendeur de chaîne / Kettenspanner
- B 74 support béquille / Träger für Ständeraufnahme

## LEVIERS BREMS UND KUPPLUNGSHABEL

---

- B 78 kit levier / kit klappbare Hebel
- B 81 levier de frein - embrayage / Bremshebel- Kupplungshebel
- B 88 pièce de rechange / Ersatzteile

## SUPPORT DEMI GUIDON LENKERSCHELLEN

---

- A 90 demi guidon et support / Lenkerschellen und Lenkerstummel

## PROTECTION LEVIERS HEBELPROTEKTOR

---

- B 94 protection leviers / Hebelprotektor

## ACCESSOIRES POUR GUIDON ZUBEHÖR FÜR LENKER

---

- B 100 embouts de guidon / Lenkergewichte

## RÉTROVISEURS SPIEGEL

---

- A 108 aluminium / Aluminium

## COUVRE RÉTROVISEUR SPIEGEL ABDECKUNG

---

- B 112 couvre rétroviseur colorés / farbige Spiegel Abdeckungen

## SUPPORT DE PLAQUE KENNZEICHENHALTER

---

- B 116 support de plaque réglable / Verstellbare Kennzeichenhalter

## FEUX BELEUCHTUNG

---

- A 130 feux / Beleuchtung

## PROTECTION EN ALUMINIUM ALUMINIUM PROTEKTOREN

---

- B 144 protection en aluminium / Aluminium Protektoren

## PROTECTION PROTEKTOREN

---

- B 150 protection de cadre / Rahmenprotektoren
- B 153 rechange protection de cadre / Ersatzteile für Protektoren

## PROTECTION AXE DE ROUE RADACHSE PROTEKTOREN

- B 156 protection axe de roue / Radachse Protektoren

## VISSERIE SCHRAUBEN

- B 160 visserie en Ergal 7075 / Ergal 7075 Schrauben  
 C 162 titane / Titan Schrauben  
 B 164 speciales en Ergal 7075 / Spezial Ergal 7075 Schrauben  
 B 166 percées / Gelochte Schrauben  
 B 166 vis parker Ergal 7075 / Selbstschneidende Ergal 7075 Schrauben  
 B 167 vis zeus et écrous zeus / Schnellverschluss Schrauben  
 B 168 écroux er rondelles/ Muttern Schrauben und Unterlegscheiben Schrauben  
 C 170 vis disque frein / Spezialschrauben für Bremsscheiben Schrauben

## KITS VIS SCHRAUBEN SETS

- B 172 kits vis / Schrauben Sets

## ÉCROUX SPECIAUX SPEZIALMUTTERN

- B 176 écroux speciaux / Spezialmuttern

## BOUCHONS VERSCHLÜSSE

- A 180 bouchons de réservoir / Tankdeckel  
 B 185 reservoir pour frein et embrayage / Brems/Kupplungsöl Tankdeckel  
 B 186 bouchons d'huile / Ölverschlusschraube  
 B 188 cache bocal liquide de frein et embrayage / Bremspumpe und Kupplungsdeckel

## CARBONE CARBON

- C 194 accessoires en carbone / Carbon-Komponenten

## BÉQUILLES STÄNDER - RACING & BOX

- D 206 béquilles / Ständer  
 A 212 accessoires pour box / Zubehör für box  
 B 214 sliders / Knieschleifer

## ADHÉSIFS AUFKLEBER

- B 216 adhésifs / Aufkleber

## 224 APPAREL BY LIGHTECH

## 228 YAMAHA T-MAX 560

A	B	C	D	E
---	---	---	---	---



# LIGHTTECH

## italianracingcomponents

En 1997, Fabrizio Furlan crée Lighttech pour apporter les compétences productives de sa famille et de profession de pilote dans l'excitant monde des motos de course. Collaborer avec des prestigieux team dans le Championnat Mondiale Superbike, Moto GP, Moto 2GP et 125 GP a permis à Lighttech de développer et devenir leader dans le domaine des accessoires pour motos. Aujourd'hui, Lighttech se développe sur une surface de 2.500 m<sup>2</sup>, ainsi subdivisée: 1.400 dédiée à la production avec sophistiqués tours et fraise à contrôle numérique (CNC), 600 à la zone entrepôt et stockage, 50 au département Recherche et Développement où les ingénieurs utilisent programme de dessin technique (CAD) et production (CAM) assistés des ordinateurs pour projeter. Autre à la siège principale, Lighttech dispose d'un autre établissement de 1.600 m<sup>2</sup> doté des implantations pour la production des commandes reculées, leviers frein-embayage et support de plaque.

In 1997 gründete Fabrizio Furlan die Firma Lighttech um seiner Familie die aufregende Welt des Motorradsports näher zu bringen. In enger Zusammenarbeit mit Elite-Teams in der Superbike-WM, Moto GP, 125 GP und Moto 2 konnte Lighttech zu einem der führenden Hersteller von technologisch fortschrittlichsten Performance-Teilen und Zubehör werden. Heute ist die Fabrik von Lighttech 2.500 Quadratmetern groß, von denen 1.400 m<sup>2</sup> auf die Produktion mit Computer-numeric-Steuerung (CNC) Maschinen entfallen, 600 m<sup>2</sup> Lagerfläche und 50m<sup>2</sup> für die Forschungs- und Entwicklungsabteilung, wo Ingenieure Computer- Aided Design (CAD) und computergestützte Fertigung (CAM)-Programme nutzen. Neben dem Stammwerk hat Lighttech eine Tochtergesellschaft mit einer 1.600 m<sup>2</sup> großen Anlage zur Herstellung von Rastenanlagen, Brems und Kupplungshebeln und Nummernschild Haltern.

### EFFICIENTAMENTO ENERGETICO DELL'IMPRESA LIGHTTECH SRL



Un moltiplicatore di opportunità. Da non lasciare sfuggire.

**Descrizione degli interventi realizzati:**

- Diagnosi energetica della struttura produttiva edificio-impianto;
- Installazione impianto solare fotovoltaico di potenza 123,69kWp;
- Relamping parziale con installazione di corpi illuminanti sostitutivi a LED;
- Installazione centro di lavoro CNC sostitutivo ad elevata efficienza energetica.

Intervento realizzato avvalendosi del finanziamento  
POR - Obiettivo "Investimenti a favore della crescita e dell'occupazione"  
Parte FESR fondo europeo di sviluppo regionale 2014-2020

ASSE 4 AZIONE 4.2.1







BORN  
TO BE  
MOTO

[www.lightech.it](http://www.lightech.it)

 **LightTech**  
Italian racing components





Le catalogue Lightech contient plus de 7.000 produits en Ergal qui sont réalisées en plusieurs coloration, 400 produits en titane et une série des nombreuses autres accessoires. Lightech peut compter sur un réseau de vente structurée actuellement en outre 1.500 détaillants autorisées en Italie et distributeurs en autre 50 pays. Ce réseau est en continue élargissement.

Der Produktionsumfang von Lightech ist sehr vielfältig. Der Katalog enthält über 7.000 Ergal Aluminium Produkte, die in sieben verschiedenen Farben hergestellt werden, über 400 Titan-Produkte und viele andere Accessoires. Lightech hat mehr als 1.500 autorisierte Händler in Italien und Distributoren in 50 Ländern.



# BORN TO BE MOTO

[www.lightech.it](http://www.lightech.it)



FUEL TANK CAPS

CARBON  
HEAD COVER

CARBON  
SEAT COVER

LICENSE PLATE  
HOLDERS

CARBON  
REAR MUDGUARD

CARBON  
ARM PROTECTOR

REAR SETS

CARBON  
ELECTRIC COVER

STAND



Années des sponsorisations techniques, l'utilisation d'un design et méthodes à l'avant-garde, et la passion pour les motos de course, sont les raisons pour lesquelles se trouvent qualité et innovation sur chaque produit Lightech.

Jahrelange Erfahrung im technischen Sponsoring, sowie der Einsatz modernster Konstruktions- und Fertigungsmethoden plus der Leidenschaft für Motorradrennen sind die Gründe dafür, dass Sie Qualität und Innovation in jedem Lightech Produkt wiederfinden. Das können Sie uns glauben.



## 2021 / 2022 • TECHNICAL SPONSOR

**SPEEDUP**

**ROSSO CORSA**

**TEAM Roc'n'DeA**







**BORN  
TO BE  
MOTO**

[www.lighttech.it](http://www.lighttech.it)

**BORN  
TO BE  
MOTO**





**COMMANDES  
RÉCULÉES  
FUSSRASTENANLAGEN**





Toutes les commandes réculées LighTech sont **100%** conçues et fabriquées dans notre usine.

Alle LighTech-Fußrastenanlage werden zu **100%** in unserer Fabrik entwickelt und hergestellt.



Carbone "White R" - Carbon "White R"



Aluminium - Aluminium



Carbone - Carbon



Magnésium - Magnesium

**Protège talon  
Fersenschützer**

voir page 60 / siehe Seite 60

TUV Homologated

**FTR\_\_KBA90967**



**Repose pied fixe  
Nicht klappbare rasten**



**Repose pied repliable  
Klappbare fußraste**

voir page 56 / siehe Seite 56

**Support repose pied  
Träger für rasten**

voir page 58 / siehe Seite 58

**Embout selecteur articulés  
Gelenkschaltspitze**

voir page 61 / siehe Seite 61



Avec les modèles de motos **EURO 4**, les commandes reculées achetées pour un usage routier doivent être strictement équipées de repose-pieds rabattables comme l'exige l'ABE - Für die Nutzung der Fussrastenanlage im öffentlichen Straßenverkehr ab Modelle mit **E4** sind klappbare Rasten erforderlich.

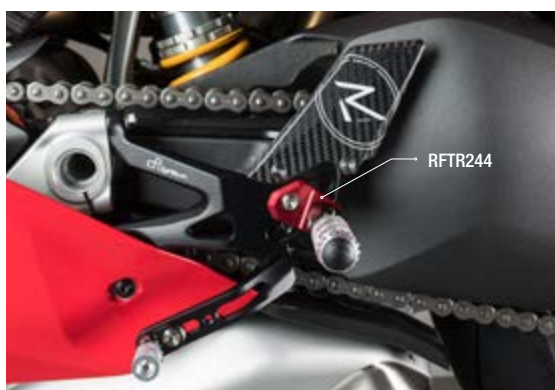

## Standard

CONFIGURATION STANDARD DE COMMANDE RECULÉE:  
repose-pieds fixes, embouts fixes, protège-talons en magnésium.

STANDARD-FUSSRASTENKONFIGURATION:  
nicht klappbare Rasten, Schaltspitze, Fersenschutz aus Magnesium.

## W Version

CONFIGURATION DE COMMANDE RECULÉE "W":  
repose-pieds rabattables, embouts fixes, protège-talons en magnésium.

"W"-FUSSRASTENKONFIGURATION:  
klappbare Rasten, Schaltspitze, Fersenschutz aus Magnesium.

## R Version

CONFIGURATION DE COMMANDE RECULÉE "R":  
repose-pieds rabattables, embouts rabattables, protège-talons en carbone, vis en titane, supports repose pied rouges.

„R“-FUSSRASTENKONFIGURATION:  
klappbare Fußrasten, Gelenkschaltspitze, Carbon-Fersenschutz, Titanschrauben, rote Träger für Rasten.

## RFTR244

Les kits support pour repose pied "UP & DOWN" permettent une extension supplémentaire des ajustements.

"Up & Down" Kit Halterung für die Raste ermöglichen eine weitere Erweiterung der Einstellungen.

Avec les modèles de motos EURO 4, les commandes reculées achetées pour un usage routier doivent être strictement équipées de repose-pieds rabattables comme l'exige l'ABE - Für die Nutzung der Fussrastenanlage im öffentlichen Straßenverkehr ab Modelle mit E4 sind klappbare Rasten erforderlich.



**RS 660 / TUONO 660**

Année / Jahr: 20-22

TÜV homologated	YES
-----------------	-----

Vitesse / Schaltung: standard - reverse

Repose pied fixe  
Mit nicht klappbarer Rasten FTRAP007 € 641,10

Repose pied pliable  
Auf Kugellager mit klappbaren Rasten FTRAP007W € 700,60

"R" version FTRAP007R € 884,90

Compatible avec RFTR244 Kompatibel mit RFTR244	YES
---	-----





Avec les modèles de motos **EURO 4**, les commandes reculées achetées pour un usage routier doivent être strictement équipées de repose-pieds rabattables comme l'exige l'ABE - Für die Nutzung der Fussrastenanlage im öffentlichen Straßenverkehr ab Modelle mit **E4** sind klappbare Rasten erforderlich.



### RSV4 RF / RR / 1100 FACTORY TUONO V4 / 1100 FACTORY

Année / Jahr: 18-22

TÜV homologated

YES

Vitesse / Schaltung: standard

Repose pied fixe  
Mit nicht klappbarer Rasten FTRAP005 € 457,90

Repose pied pliable  
Auf Kugellager  
mit klappbaren Rasten FTRAP005W € 517,40

"R" version FTRAP005R € 702,90

Vitesse / Schaltung: reverse

Repose pied fixe  
Mit nicht klappbarer Rasten FTRAP006 € 475,10

Repose pied pliable  
Auf Kugellager  
mit klappbaren Rasten FTRAP006W € 532,30

"R" version FTRAP006R € 715,50

Compatible avec RFTR244  
Kompatibel mit RFTR244

YES



Avec les modèles de motos EURO 4, les commandes reculées achetées pour un usage routier doivent être strictement équipées de repose-pieds rabattables comme l'exige l'ABE - Für die Nutzung der Fussrastenanlage im öffentlichen Straßenverkehr ab Modelle mit E4 sind klappbare Rasten erforderlich.



**RSV4**

Année / Jahr: 09-17

**TUONO V4**

Année / Jahr: 11-17

TÜV homologated	YES
-----------------	-----

Vitesse / Schaltung: standard

Repose pied fixe  
Mit nicht klappbarer Rasten FTRAP004 € 440,70

Repose pied pliable  
Auf Kugellager mit klappbaren Rasten FTRAP004W € 500,30

"R" version FTRAP004R € 684,60

Compatible avec RFTR244 Kompatibel mit RFTR244	NOT
---	-----



Kit de conversion à vitesse inversé pour réf. FTRAP004-W-R  
Kit Schaltbildänderung von Standard in Reverse für Mod. FTRAP004-W-R



RFTR236 € 143,10

Avec les modèles de motos **EURO 4**, les commandes reculées achetées pour un usage routier doivent être strictement équipées de repose-pieds rabattables comme l'exige l'ABE - Für die Nutzung der Fussrastenanlage im öffentlichen Straßenverkehr ab Modelle mit **E4** sind klappbare Rasten erforderlich.

**S1000RR**

Année / Jahr: 19-22

**M1000RR**Année / Jahr: 21-22 **NOT TÜV HOMOLOGATED!**

TÜV homologated

YES

Vitesse / Schaltung: standar - reverse

Repose pied fixe  
Mit nicht klappbarer Rasten FTRBM007 € 532,30

Repose pied pliable  
Auf Kugellager  
mit klappbaren Rasten FTRBM007W € 589,60

"R" version FTRBM007R € 772,70

Compatible avec RFTR244  
Kompatibel mit RFTR244

YES



Support pour levier de vitesse pour usage racing (sans béquille latérale)

Halterung für Schaltstange - Racing (ohne Seitenständer)

Année / Jahr: 19-22

FTR840NER € 52,70



Avec les modèles de motos EURO 4, les commandes reculées achetées pour un usage routier doivent être strictement équipées de repose-pieds rabattables comme l'exige l'ABE - Für die Nutzung der Fussrastenanlage im öffentlichen Straßenverkehr ab Modelle mit E4 sind klappbare Rasten erforderlich.

BMW



**S1000R**

Année / Jahr: 17-20

**S1000RR / HP4**

Année / Jahr: 15-18

TÜV homologated	YES
-----------------	-----

Vitesse / Schaltung: standard - reverse

Repose pied fixe Mit nicht klappbarer Rasten	FTRBM004	€ 500,30
---	----------	----------

Repose pied pliable Auf Kugellager mit klappbaren Rasten	FTRBM004W	€ 559,80
--	-----------	----------

"R" version	FTRBM004R	€ 744,10
-------------	-----------	----------

Compatible avec RFTR244 Kompatibel mit RFTR244	NOT
---	-----



Avec les modèles de motos **EURO 4**, les commandes reculées achetées pour un usage routier doivent être strictement équipées de repose-pieds rabattables comme l'exige l'ABE - Für die Nutzung der Fussrastenanlage im öffentlichen Straßenverkehr ab Modelle mit **E4** sind klappbare Rasten erforderlich.

**S1000R**

Année / Jahr: 14-16

**S1000RR / HP4**

Année / Jahr: 09-14

TÜV homologated

YES

Vitesse / Schaltung: standard

**Repose pied fixe**

Mit nicht klappbarer Rasten FTRBM001 € 473,90

**Repose pied pliable**

Auf Kugellager mit klappbaren Rasten FTRBM001W € 533,50

"R" version

FTRBM001R € 717,80

Compatible avec RFTR244  
Kompatibel mit RFTR244

YES



Kit de conversion à vitesse inversé pour réf. FTRBM001-W-R  
Kit Schaltbildänderung von Standard in Reverse für Mod. FTRBM001-W-R

RFTR164 € 196,90



Avec les modèles de motos EURO 4, les commandes reculées achetées pour un usage routier doivent être strictement équipées de repose-pieds rabattables comme l'exige l'ABE - Für die Nutzung der Fussrastenanlage im öffentlichen Straßenverkehr ab Modelle mit E4 sind klappbare Rasten erforderlich.



**S1000R**

Année / Jahr: 14-16

**S1000RR / HP4**

Année / Jahr: 09-14

TÜV homologated	YES
-----------------	-----

Vitesse / Schaltung: reverse

Repose pied fixe  
Mit nicht klappbarer Rasten FTRBM002 € 500,30

Repose pied pliable  
Auf Kugellager mit klappbaren Rasten FTRBM002W € 559,80

"R" version FTRBM002R € 744,10

Compatible avec RFTR244 Kompatibel mit RFTR244	YES
---	-----

BMW

Kit de conversion de enversé à standard pour réf. FTRBM002-W-R  
Kit Schaltbildänderung von umgedreht auf standard für Mod. FTRBM002-W-R



RFTR207 € 77,80



**R NINE-T / SCRAMBLER  
PURE / URBAN / RACER**

Année / Jahr: 16-19

TÜV homologated

NOT

Vitesse / Schaltung: standard

Repose pied pliable  
Auf Kugellager  
mit klappbaren Rasten

**FTRBM005W**

€ 654,80

! FINE DE LA SÉRIE - AUSLAUFARTIKEL



**R1200 GS**

Année / Jahr: 13-18

TÜV homologated

NOT

Vitesse / Schaltung: standard

Repose pied pliable  
Auf Kugellager  
mit klappbaren Rasten

**FTRBM006NERW**

€ 263,30

! FINE DE LA SÉRIE - AUSLAUFARTIKEL



Repose pied pliable  
Auf Kugellager  
mit klappbaren Rasten

**FTRBM006COBW**

€ 263,30

! FINE DE LA SÉRIE - AUSLAUFARTIKEL



Repose pied pliable  
Auf Kugellager  
mit klappbaren Rasten

**FTRBM006ROSW**

€ 263,30

! FINE DE LA SÉRIE - AUSLAUFARTIKEL

Avec les modèles de motos EURO 4, les commandes reculées achetées pour un usage routier doivent être strictement équipées de repose-pieds rabattables comme l'exige l'ABE - Für die Nutzung der Fussrastenanlage im öffentlichen Straßenverkehr ab Modelle mit E4 sind klappbare Rasten erforderlich.



**PANIGALE V4 / V4 S / V4 R / SPECIALE**

Année / Jahr: 18-21

**STREETFIGHTER V4 / V4 S**

Année / Jahr: 20-21

TÜV homologated	YES
-----------------	-----

Vitesse / Schaltung: standard - reverse

Repose pied fixe Mit nicht klappbarer Rasten	FTRDU012	€ 708,60
---	----------	----------

Repose pied pliable Auf Kugellager mit klappbaren Rasten	FTRDU012W	€ 768,20
--	-----------	----------

"R" version	FTRDU012R	€ 952,50
-------------	-----------	----------

Compatible avec RFTR244 Kompatibel mit RFTR244	YES
---	-----

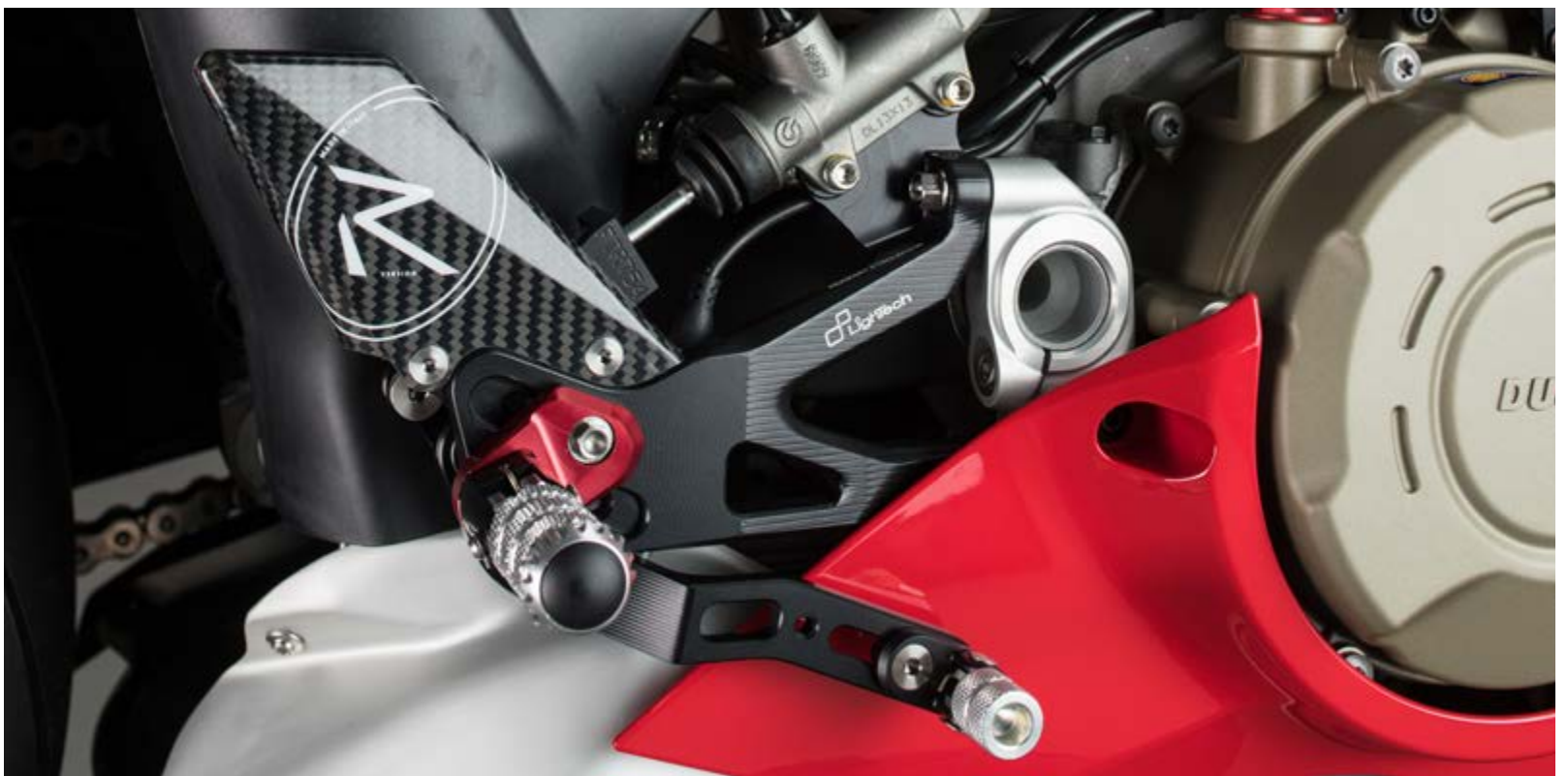

Avec les modèles de motos **EURO 4**, les commandes reculées achetées pour un usage routier doivent être strictement équipées de repose-pieds rabattables comme l'exige l'ABE - Für die Nutzung der Fussrastenanlage im öffentlichen Straßenverkehr ab Modelle mit **E4** sind klappbare Rasten erforderlich.

**PANIGALE 899 / 1199 / 1299**

Année / Jahr: 12-17

**PANIGALE 959**

Année / Jahr: 16-20

**PANIGALE V2 955**

Année / Jahr: 20-22

TÜV homologated	YES
-----------------	-----

Vitesse / Schaltung: standard

Repose pied fixe Mit nicht klappbarer Rasten	FTRDU010	€ 708,60
---	----------	----------

Repose pied pliable Auf Kugellager mit klappbaren Rasten	FTRDU010W	€ 768,20
--	-----------	----------

"R" version	FTRDU010R	€ 952,50
-------------	-----------	----------

Vitesse / Schaltung: reverse

Repose pied fixe Mit nicht klappbarer Rasten	FTRDU011	€ 708,60
---	----------	----------

Repose pied pliable Auf Kugellager mit klappbaren Rasten	FTRDU011W	€ 768,20
--	-----------	----------

"R" version	FTRDU011R	€ 952,50
-------------	-----------	----------

Compatible avec RFTR244 Kompatibel mit RFTR244	NOT
---	-----



Kit de conversion à vitesse inversé pour réf. FTRDU010-W-R  
Kit Schaltbildänderung von Standard in Reverse für Mod. FTRDU010-W-R



RFTR192 € 71,60

Kit de conversion de inversé à standard pour réf. FTRDU011-W-R  
Kit Schaltbildänderung von umgedreht auf standard für Mod. FTRDU011-W-R



RFTR191 € 77,80



Avec les modèles de motos EURO 4, les commandes reculées achetées pour un usage routier doivent être strictement équipées de repose-pieds rabattables comme l'exige l'ABE - Für die Nutzung der Fussrastenanlage im öffentlichen Straßenverkehr ab Modelle mit E4 sind klappbare Rasten erforderlich.

HONDA



**CB1000R**

Année / Jahr: 18-20

TÜV homologated	YES
-----------------	-----

Vitesse / Schaltung: standard - reverse

Repose pied fixe Mit nicht klappbarer Rasten	FTRH0008	€ 457,90
---	----------	----------

Repose pied pliable Auf Kugellager mit klappbaren Rasten	FTRH0008W	€ 517,40
--	-----------	----------

"R" version	FTRH0008R	€ 702,90
-------------	-----------	----------

Compatible avec RFTR244 Kompatibel mit RFTR244	NOT
---	-----



Avec les modèles de motos **EURO 4**, les commandes reculées achetées pour un usage routier doivent être strictement équipées de repose-pieds rabattables comme l'exige l'ABE - Für die Nutzung der Fussrastenanlage im öffentlichen Straßenverkehr ab Modelle mit **E4** sind klappbare Rasten erforderlich.

**CBR 600 RR**

Année / Jahr: 07-16

TÜV homologated	YES
-----------------	-----

Vitesse / Schaltung: standard - reverse

Repose pied fixe Mit nicht klappbarer Rasten	FTRH0005	€ 457,90
Repose pied pliable Auf Kugellager mit klappbaren Rasten	FTRH0005W	€ 517,40

"R" version	FTRH0005R	€ 702,90
-------------	-----------	----------

Compatible avec RFTR244 Kompatibel mit RFTR244	NOT
---	-----



Avec les modèles de motos EURO 4, les commandes reculées achetées pour un usage routier doivent être strictement équipées de repose-pieds rabattables comme l'exige l'ABE - Für die Nutzung der Fussrastenanlage im öffentlichen Straßenverkehr ab Modelle mit E4 sind klappbare Rasten erforderlich.



**CBR 1000 RR-R / SP**

Année / Jahr: 20-22

TÜV homologated	YES
-----------------	-----

Vitesse / Schaltung: standard - reverse

Repose pied fixe Mit nicht klappbarer Rasten	FTRH0011	€ 475,10
---	----------	----------

Repose pied pliable Auf Kugellager mit klappbaren Rasten	FTRH0011W	€ 532,30
--	-----------	----------

"R" version	FTRH0011R	€ 715,50
-------------	-----------	----------

Compatible avec RFTR244 Kompatibel mit RFTR244	YES
---	-----

HONDA



Support pour levier de vitesse pour usage racing (sans béquille latérale)  
Halterung für Schaltstange - Racing (ohne Seitenständer)  
Année / Jahr: 20-22

FTR883NER € 59,50

Avec les modèles de motos **EURO 4**, les commandes reculées achetées pour un usage routier doivent être strictement équipées de repose-pieds rabattables comme l'exige l'ABE - Für die Nutzung der Fussrastenanlage im öffentlichen Straßenverkehr ab Modelle mit **E4** sind klappbare Rasten erforderlich.

**CBR 1000 RR**

Année / Jahr: 08-19

TÜV homologated	YES
-----------------	-----

Vitesse / Schaltung: standard - reverse

Repose pied fixe  
Mit nicht klappbarer Rasten FTRH0006 € 470,50

Repose pied pliable  
Auf Kugellager  
mit klappbaren Rasten FTRH0006W € 530,00

"R" version FTRH0006R € 713,20

Compatible avec RFTR244 Kompatibel mit RFTR244	NOT
---	-----







**X-ADV**

Année / Jahr: 21-22

TÜV homologated	NOT
-----------------	-----

Repose pied pliable  
Auf Kugellager  
mit klappbaren Rasten      FTRH0012NER      € 332,00

Repose pied pliable  
Auf Kugellager  
mit klappbaren Rasten      FTRH0012COB      € 332,00

Repose pied pliable  
Auf Kugellager  
mit klappbaren Rasten      FTRH0012ROS      € 332,00





**X-ADV**

Année / Jahr: 17-20

TÜV homologated	NOT
-----------------	-----

Repose pied pliable  
Auf Kugellager  
mit klappbaren Rasten FTRH009NER € 360,60



Repose pied pliable  
Auf Kugellager  
mit klappbaren Rasten FTRH009COB € 360,60



Repose pied pliable  
Auf Kugellager  
mit klappbaren Rasten FTRH009ROS € 360,60

HONDA



Avec les modèles de motos EURO 4, les commandes reculées achetées pour un usage routier doivent être strictement équipées de repose-pieds rabattables comme l'exige l'ABE - Für die Nutzung der Fussrastenanlage im öffentlichen Straßenverkehr ab Modelle mit E4 sind klappbare Rasten erforderlich.

KAWASAKI



**Z 900**

Année / Jahr: 17-22

TÜV homologated	YES
-----------------	-----

Vitesse / Schaltung: standard - reverse

Repose pied fixe  
Mit nicht klappbarer Rasten FTRKA010 € 440,70

Repose pied pliable  
Auf Kugellager  
mit klappbaren Rasten FTRKA010W € 500,30

"R" version FTRKA010R € 684,60

Compatible avec RFTR244 Kompatibel mit RFTR244	YES
---	-----

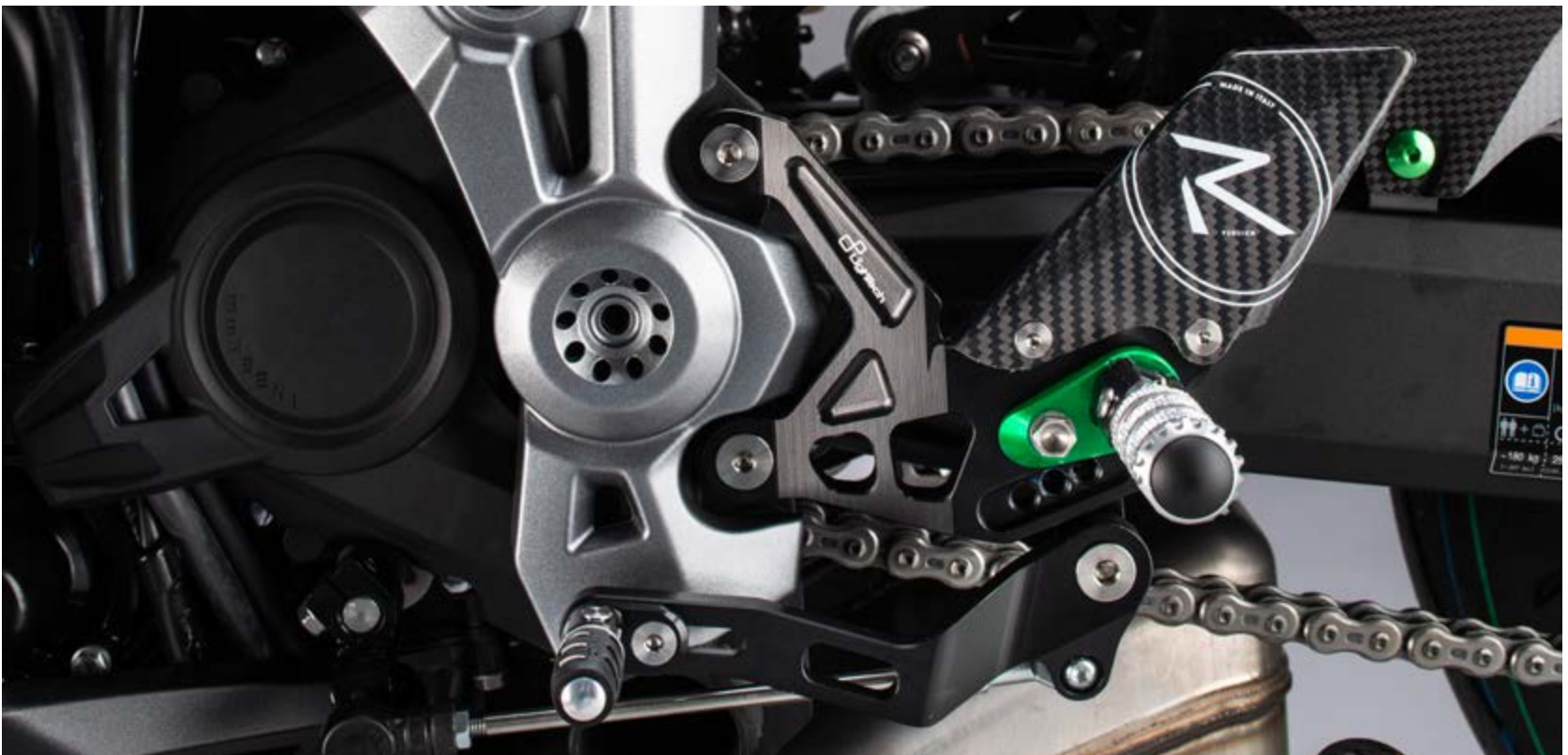



Avec les modèles de motos **EURO 4**, les commandes reculées achetées pour un usage routier doivent être strictement équipées de repose-pieds rabattables comme l'exige l'ABE - Für die Nutzung der Fussrastenanlage im öffentlichen Straßenverkehr ab Modelle mit **E4** sind klappbare Rasten erforderlich.

**ZX10R**

Année / Jahr: 21-22

TÜV homologated

YES

Vitesse / Schaltung: standard

Repose pied fixe  
Mit nicht klappbarer Rasten FTRKA011 € 457,90

Repose pied pliable  
Auf Kugellager  
mit klappbaren Rasten FTRKA011W € 517,40

"R" version FTRKA011R € 702,90

Vitesse / Schaltung: reverse

Repose pied fixe  
Mit nicht klappbarer Rasten FTRKA012 € 475,10

Repose pied pliable  
Auf Kugellager  
mit klappbaren Rasten FTRKA012W € 532,30

"R" version FTRKA012R € 715,50

Compatible avec RFTR244  
Kompatibel mit RFTR244

YES



Avec les modèles de motos EURO 4, les commandes reculées achetées pour un usage routier doivent être strictement équipées de repose-pieds rabattables comme l'exige l'ABE - Für die Nutzung der Fussrastenanlage im öffentlichen Straßenverkehr ab Modelle mit E4 sind klappbare Rasten erforderlich.

KAWASAKI



**NINJA 400**

Année / Jahr: 18-21

TÜV homologated	YES
-----------------	-----

Vitesse / Schaltung: standard - reverse

Repose pied fixe Mit nicht klappbarer Rasten	FTRKA007	€ 377,80
---	----------	----------

Repose pied pliable Auf Kugellager mit klappbaren Rasten	FTRKA007W	€ 435,00
--	-----------	----------

"R" version	FTRKA007R	€ 612,50
-------------	-----------	----------

Compatible avec RFTR244 Kompatibel mit RFTR244	NOT
---	-----



Avec les modèles de motos **EURO 4**, les commandes reculées achetées pour un usage routier doivent être strictement équipées de repose-pieds rabattables comme l'exige l'ABE - Für die Nutzung der Fussrastenanlage im öffentlichen Straßenverkehr ab Modelle mit **E4** sind klappbare Rasten erforderlich.

**ZX6R - 636**

Année / Jahr: 05-21

TÜV homologated	YES
-----------------	-----

Vitesse / Schaltung: standard

Repose pied fixe Mit nicht klappbarer Rasten	FTRKA008	€ 440,70
---	----------	----------

Repose pied pliable Auf Kugellager mit klappbaren Rasten	FTRKA008W	€ 500,30
--	-----------	----------

"R" version	FTRKA008R	€ 684,60
-------------	-----------	----------

Vitesse / Schaltung: reverse

Repose pied fixe Mit nicht klappbarer Rasten	FTRKA009	€ 457,90
---	----------	----------

Repose pied pliable Auf Kugellager mit klappbaren Rasten	FTRKA009W	€ 517,40
--	-----------	----------

"R" version	FTRKA009R	€ 702,90
-------------	-----------	----------

Compatible avec RFTR244 Kompatibel mit RFTR244	YES
---	-----



Avec les modèles de motos EURO 4, les commandes reculées achetées pour un usage routier doivent être strictement équipées de repose-pieds rabattables comme l'exige l'ABE - Für die Nutzung der Fussrastenanlage im öffentlichen Straßenverkehr ab Modelle mit E4 sind klappbare Rasten erforderlich.

KAWASAKI



**ZX10R**

Année / Jahr: 16-20

TÜV homologated	YES
-----------------	-----

Vitesse / Schaltung: standard

Repose pied fixe Mit nicht klappbarer Rasten	FTRKA006	€ 457,90
---	----------	----------

Repose pied pliable Auf Kugellager mit klappbaren Rasten	FTRKA006W	€ 517,40
--	-----------	----------

"R" version	FTRKA006R	€ 702,90
-------------	-----------	----------

Compatible avec RFTR244 Kompatibel mit RFTR244	NOT
---	-----

Kit de conversion à vitesse inversé pour réf. FTRKA006-W-R  
Kit Schaltbildänderung von Standard in Reverse für Mod. FTRKA006-W-R  
Année / Jahr: 16-20



RFTR232 € 143,10

Avec les modèles de motos **EURO 4**, les commandes reculées achetées pour un usage routier doivent être strictement équipées de repose-pieds rabattables comme l'exige l'ABE - Für die Nutzung der Fussrastenanlage im öffentlichen Straßenverkehr ab Modelle mit **E4** sind klappbare Rasten erforderlich.

**ZX10R**

Année / Jahr: 11-15

TÜV homologated	YES
-----------------	-----

Vitesse / Schaltung: standard - reverse

Repose pied fixe  
Mit nicht klappbarer Rasten FTRKA003 € 440,70

Repose pied pliable  
Auf Kugellager  
mit klappbaren Rasten FTRKA003W € 500,30

"R" version FTRKA003R € 684,60

Compatible avec RFTR244 Kompatibel mit RFTR244	NOT
---	-----





Avec les modèles de motos EURO 4, les commandes reculées achetées pour un usage routier doivent être strictement équipées de repose-pieds rabattables comme l'exige l'ABE - Für die Nutzung der Fussrastenanlage im öffentlichen Straßenverkehr ab Modelle mit E4 sind klappbare Rasten erforderlich.

KTM



**DUKE 790**

Année / Jahr: 18-22

**DUKE 890 R**

Année / Jahr: 20-22

TÜV homologated	YES
-----------------	-----

Vitesse / Schaltung: standard - reverse

Repose pied fixe Mit nicht klappbarer Rasten	FTRKT002	€ 470,50
---	----------	----------

Repose pied pliable Auf Kugellager mit klappbaren Rasten	FTRKT002W	€ 530,00
--	-----------	----------

"R" version	FTRKT002R	€ 713,20
-------------	-----------	----------

Compatible avec RFTR244 Kompatibel mit RFTR244	YES
---	-----





**RC 125 / RC 200 / RC 390**

Année / Jahr: 17-20

**FOR RACING USE ONLY**

TÜV homologated

NOT

Vitesse / Schaltung: standard - reverse

Repose pied fixe  
Mit nicht klappbarer Rasten FTRKT001 € 675,40

Repose pied pliable  
Auf Kugellager  
mit klappbaren Rasten FTRKT001W € 735,00

KTM



Avec les modèles de motos EURO 4, les commandes reculées achetées pour un usage routier doivent être strictement équipées de repose-pieds rabattables comme l'exige l'ABE - Für die Nutzung der Fussrastenanlage im öffentlichen Straßenverkehr ab Modelle mit E4 sind klappbare Rasten erforderlich.



**B3 675**

Année / Jahr: 11-15

**B3 800 / DRAGSTER 800**

Année / Jahr: 13-16

TÜV homologated	YES
-----------------	-----

Not compatible with EURO 4 models

Vitesse / Schaltung: standard - reverse

Repose pied fixe  
Mit nicht klappbarer Rasten **FTRMV003** € 470,50

! FINE DE LA SÉRIE - AUSLAUFARTIKEL

Repose pied pliable  
Auf Kugellager  
mit klappbaren Rasten **FTRMV003W** € 530,00

! FINE DE LA SÉRIE - AUSLAUFARTIKEL

"R" version **FTRMV003R** € 713,20

! FINE DE LA SÉRIE - AUSLAUFARTIKEL

Compatible avec RFTR244 Kompatibel mit RFTR244	YES
---	-----



Avec les modèles de motos EURO 4, les commandes reculées achetées pour un usage routier doivent être strictement équipées de repose-pieds rabattables comme l'exige l'ABE - Für die Nutzung der Fussrastenanlage im öffentlichen Straßenverkehr ab Modelle mit E4 sind klappbare Rasten erforderlich.



**GSX-R 600 / GSXR 750**

Année / Jahr: 11-17

TÜV homologated	YES
-----------------	-----

Vitesse / Schaltung: standard - reverse

Repose pied fixe Mit nicht klappbarer Rasten	FTRSU002	€ 440,70
---	----------	----------

Repose pied pliable Auf Kugellager mit klappbaren Rasten	FTRSU002W	€ 500,30
--	-----------	----------

"R" version	FTRSU002R	€ 684,60
-------------	-----------	----------

Compatible avec RFTR244 Kompatibel mit RFTR244	NOT
---	-----

SUZUKI

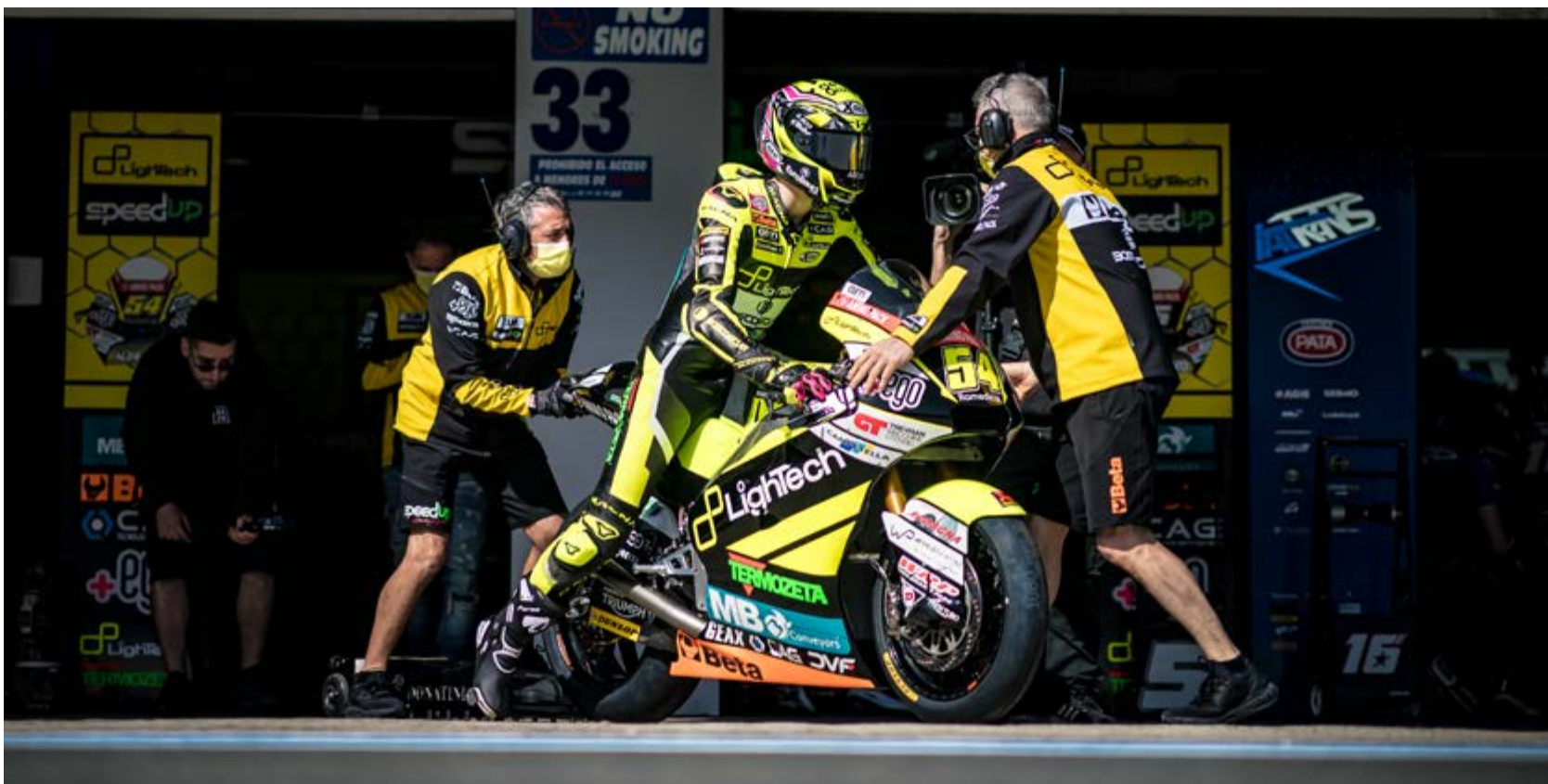

Avec les modèles de motos EURO 4, les commandes reculées achetées pour un usage routier doivent être strictement équipées de repose-pieds rabattables comme l'exige l'ABE - Für die Nutzung der Fussrastenanlage im öffentlichen Straßenverkehr ab Modelle mit E4 sind klappbare Rasten erforderlich.

SUZUKI



**GSX-R 1000 / GSX-R 1000 R**

Année / Jahr: 17-22

TÜV homologated	YES
-----------------	-----

Vitesse / Schaltung: standard - reverse

Repose pied fixe Mit nicht klappbarer Rasten	FTRSU004	€ 470,50
---	----------	----------

Repose pied pliable Auf Kugellager mit klappbaren Rasten	FTRSU004W	€ 530,00
--	-----------	----------

"R" version	FTRSU004R	€ 713,20
-------------	-----------	----------

Compatible avec RFTR244 Kompatibel mit RFTR244	NOT
---	-----





Avec les modèles de motos **EURO 4**, les commandes reculées achetées pour un usage routier doivent être strictement équipées de repose-pieds rabattables comme l'exige l'ABE - Für die Nutzung der Fussrastenanlage im öffentlichen Straßenverkehr ab Modelle mit **E4** sind klappbare Rasten erforderlich.

**GSX-S 1000**

Année / Jahr: 15-21

TÜV homologated	YES
-----------------	-----

Vitesse / Schaltung: standard - reverse

Repose pied fixe Mit nicht klappbarer Rasten	FTRSU003	€ 440,70
---	----------	----------

Repose pied pliable Auf Kugellager mit klappbaren Rasten	FTRSU003W	€ 500,30
--	-----------	----------

"R" version	FTRSU003R	€ 684,60
-------------	-----------	----------

Compatible avec RFTR244 Kompatibel mit RFTR244	NOT
---	-----





Avec les modèles de motos EURO 4, les commandes reculées achetées pour un usage routier doivent être strictement équipées de repose-pieds rabattables comme l'exige l'ABE - Für die Nutzung der Fussrastenanlage im öffentlichen Straßenverkehr ab Modelle mit E4 sind klappbare Rasten erforderlich.



**DAYTONA 675 / 765**

Année / Jahr: 13-21

**STREET TRIPLE 765**

Année / Jahr: 17-22

(tous / alle)

TÜV homologated	YES
-----------------	-----

Vitesse / Schaltung: standard - reverse

Repose pied fixe  
Mit nicht klappbarer Rasten FTRTR005 € 440,70

Repose pied pliable  
Auf Kugellager mit klappbaren Rasten FTRTR005W € 500,30

"R" version FTRTR005R € 684,60

Compatible avec RFTR244 Kompatibel mit RFTR244	YES
---	-----

Avec les modèles de motos **EURO 4**, les commandes reculées achetées pour un usage routier doivent être strictement équipées de repose-pieds rabattables comme l'exige l'ABE - Für die Nutzung der Fussrastenanlage im öffentlichen Straßenverkehr ab Modelle mit **E4** sind klappbare Rasten erforderlich.



### SPEED TRIPLE RS 1200 / RR 1200

Année / Jahr: 21-22

TÜV homologated

YES

Vitesse / Schaltung: standard - reverse

Repose pied fixe  
Mit nicht klappbarer Rasten FTRTR006 € 475,10

Repose pied pliable  
Auf Kugellager  
mit klappbaren Rasten FTRTR006W € 532,30

"R" version FTRTR006R € 715,50

Compatible avec RFTR244  
Kompatibel mit RFTR244

YES





**R7**

Année / Jahr: 22-22

TÜV homologated	NOT
-----------------	-----

Vitesse / Schaltung: standard - reverse

Repose pied fixe  
Mit nicht klappbarer Rasten FTRYA018 € 470,50

Repose pied pliable  
Auf Kugellager mit klappbaren Rasten FTRYA018W € 530,00

"R" version FTRYA018R € 713,20

Compatible avec RFTR244 Kompatibel mit RFTR244	YES
---	-----



Avec les modèles de motos **EURO 4**, les commandes reculées achetées pour un usage routier doivent être strictement équipées de repose-pieds rabattables comme l'exige l'ABE - Für die Nutzung der Fussrastenanlage im öffentlichen Straßenverkehr ab Modelle mit **E4** sind klappbare Rasten erforderlich.

**MT-09 / SP**

Année / Jahr: 21-22

TÜV homologated	YES
-----------------	-----

Vitesse / Schaltung: standard - reverse

Repose pied fixe Mit nicht klappbarer Rasten	FTRYA017	€ 470,50
---	----------	----------

Repose pied pliable Auf Kugellager mit klappbaren Rasten	FTRYA017W	€ 530,00
--	-----------	----------

"R" version	FTRYA017R	€ 713,20
-------------	-----------	----------

Compatible avec RFTR244 Kompatibel mit RFTR244	YES
---	-----



Avec les modèles de motos **EURO 4**, les commandes reculées achetées pour un usage routier doivent être strictement équipées de repose-pieds rabattables comme l'exige l'ABE - Für die Nutzung der Fussrastenanlage im öffentlichen Straßenverkehr ab Modelle mit **E4** sind klappbare Rasten erforderlich.



### MT-07 / MT-07 TRACER

Année / Jahr: 14-20

TÜV homologated	YES
-----------------	-----

Vitesse / Schaltung: standard

**Repose pied fixe**  
Mit nicht klappbarer Rasten FTRYA008 € 440,70

**Repose pied pliable**  
Auf Kugellager mit klappbaren Rasten FTRYA008W € 500,30

"R" version FTRYA008R € 684,60

Compatible avec RFTR244 Kompatibel mit RFTR244	NOT
---	-----

Avec les modèles de motos **EURO 4**, les commandes reculées achetées pour un usage routier doivent être strictement équipées de repose-pieds rabattables comme l'exige l'ABE - Für die Nutzung der Fussrastenanlage im öffentlichen Straßenverkehr ab Modelle mit **E4** sind klappbare Rasten erforderlich.



### MT-09 / MT-09 TRACER XSR900

Année / Jahr: 13-20

TÜV homologated	YES
-----------------	-----

Vitesse / Schaltung: standard

Repose pied fixe  
Mit nicht klappbarer Rasten FTRYA007 € 440,70

Repose pied pliable  
Auf Kugellager  
mit klappbaren Rasten FTRYA007W € 500,30

"R" version FTRYA007R € 684,60

Compatible avec RFTR244 Kompatibel mit RFTR244	NOT
---	-----



Avec les modèles de motos EURO 4, les commandes reculées achetées pour un usage routier doivent être strictement équipées de repose-pieds rabattables comme l'exige l'ABE - Für die Nutzung der Fussrastenanlage im öffentlichen Straßenverkehr ab Modelle mit E4 sind klappbare Rasten erforderlich.

YAMAHA



**MT-10 / MT-10 SP**

Année / Jahr: 16-21

TÜV homologated	YES
-----------------	-----

Vitesse / Schaltung: standard - reverse

Repose pied fixe  
Mit nicht klappbarer Rasten FTRYA011 € 511,70

Repose pied pliable  
Auf Kugellager mit klappbaren Rasten FTRYA011W € 571,30

"R" version FTRYA011R € 755,60

Compatible avec RFTR244 Kompatibel mit RFTR244	YES
---	-----



Avec les modèles de motos **EURO 4**, les commandes reculées achetées pour un usage routier doivent être strictement équipées de repose-pieds rabattables comme l'exige l'ABE - Für die Nutzung der Fussrastenanlage im öffentlichen Straßenverkehr ab Modelle mit **E4** sind klappbare Rasten erforderlich.

**R1 / R1M**

Année / Jahr: 15-22

TÜV homologated

YES

Vitesse / Schaltung: standard - reverse

Repose pied fixe  
Mit nicht klappbarer Rasten FTRYA016 € 475,10

Repose pied pliable  
Auf Kugellager  
mit klappbaren Rasten FTRYA016W € 532,30

"R" version FTRYA016R € 715,50

Compatible avec RFTR244  
Kompatibel mit RFTR244

YES



Support pour levier de vitesses et catalyseur pour R1 à partir de 2020; permet le retrait de la béquille latérale.  
Halterung für Schaltstange und Katalysator für R1 BJ ab 2020: das ermöglicht die Entfernung des seitlichen Ständer  
**Année / Jahr:** 20-22

FTR862NER € 59,50



Support pour levier de vitesses pour R1 de 2015-2019. Permet le retrait de la béquille latérale.  
Halterung für Schaltstange für R1 BJ 2015-2019: das ermöglicht die Entfernung des seitlichen Ständer.  
**Année / Jahr:** 15-19

FTR632NER € 52,70

Avec les modèles de motos EURO 4, les commandes reculées achetées pour un usage routier doivent être strictement équipées de repose-pieds rabattables comme l'exige l'ABE - Für die Nutzung der Fussrastenanlage im öffentlichen Straßenverkehr ab Modelle mit E4 sind klappbare Rasten erforderlich.



**R1**

Année / Jahr: 09-14

TÜV homologated	YES
-----------------	-----

Vitesse / Schaltung: standard - reverse

Repose pied fixe  
Mit nicht klappbarer Rasten FTRYA001 € 440,70

Repose pied pliable  
Auf Kugellager mit klappbaren Rasten FTRYA001W € 500,30

"R" version FTRYA001R € 684,60

Compatible avec RFTR244 Kompatibel mit RFTR244	NOT
---	-----





Avec les modèles de motos **EURO 4**, les commandes reculées achetées pour un usage routier doivent être strictement équipées de repose-pieds rabattables comme l'exige l'ABE - Für die Nutzung der Fussrastenanlage im öffentlichen Straßenverkehr ab Modelle mit **E4** sind klappbare Rasten erforderlich.

**R3**

Année / Jahr: 15-21

TÜV homologated	YES
-----------------	-----

Vitesse / Schaltung: standard

Repose pied fixe Mit nicht klappbarer Rasten	FTRYA013	€ 440,70
---	----------	----------

Repose pied pliable Auf Kugellager mit klappbaren Rasten	FTRYA013W	€ 500,30
--	-----------	----------

"R" version	FTRYA013R	€ 684,60
-------------	-----------	----------

Vitesse / Schaltung: reverse

Repose pied fixe Mit nicht klappbarer Rasten	FTRYA014	€ 470,50
---	----------	----------

Repose pied pliable Auf Kugellager mit klappbaren Rasten	FTRYA014W	€ 530,00
--	-----------	----------

"R" version	FTRYA014R	€ 713,20
-------------	-----------	----------



Compatible avec RFTR244 Kompatibel mit RFTR244	NOT
---	-----

Avec les modèles de motos EURO 4, les commandes reculées achetées pour un usage routier doivent être strictement équipées de repose-pieds rabattables comme l'exige l'ABE - Für die Nutzung der Fussrastenanlage im öffentlichen Straßenverkehr ab Modelle mit E4 sind klappbare Rasten erforderlich.

YAMAHA



**R6**

Année / Jahr: 17-21

TÜV homologated	YES
-----------------	-----

Vitesse / Schaltung: standard - reverse

Repose pied fixe Mit nicht klappbarer Rasten	FTRYA012	€ 470,50
---	----------	----------

Repose pied pliable Auf Kugellager mit klappbaren Rasten	FTRYA012W	€ 530,00
--	-----------	----------

"R" version	FTRYA012R	€ 713,20
-------------	-----------	----------

Compatible avec RFTR244 Kompatibel mit RFTR244	YES
---	-----



Avec les modèles de motos **EURO 4**, les commandes reculées achetées pour un usage routier doivent être strictement équipées de repose-pieds rabattables comme l'exige l'ABE - Für die Nutzung der Fussrastenanlage im öffentlichen Straßenverkehr ab Modelle mit **E4** sind klappbare Rasten erforderlich.

**R6**

Année / Jahr: 08 -16

TÜV homologated	YES
-----------------	-----

Vitesse / Schaltung: standard - reverse

Repose pied fixe  
Mit nicht klappbarer Rasten FTRYA002 € 440,70

Repose pied pliable  
Auf Kugellager  
mit klappbaren Rasten FTRYA002W € 500,30

"R" version FTRYA002R € 684,60

Compatible avec RFTR244 Kompatibel mit RFTR244	YES
---	-----



**BORN  
TO BE  
MOTO**





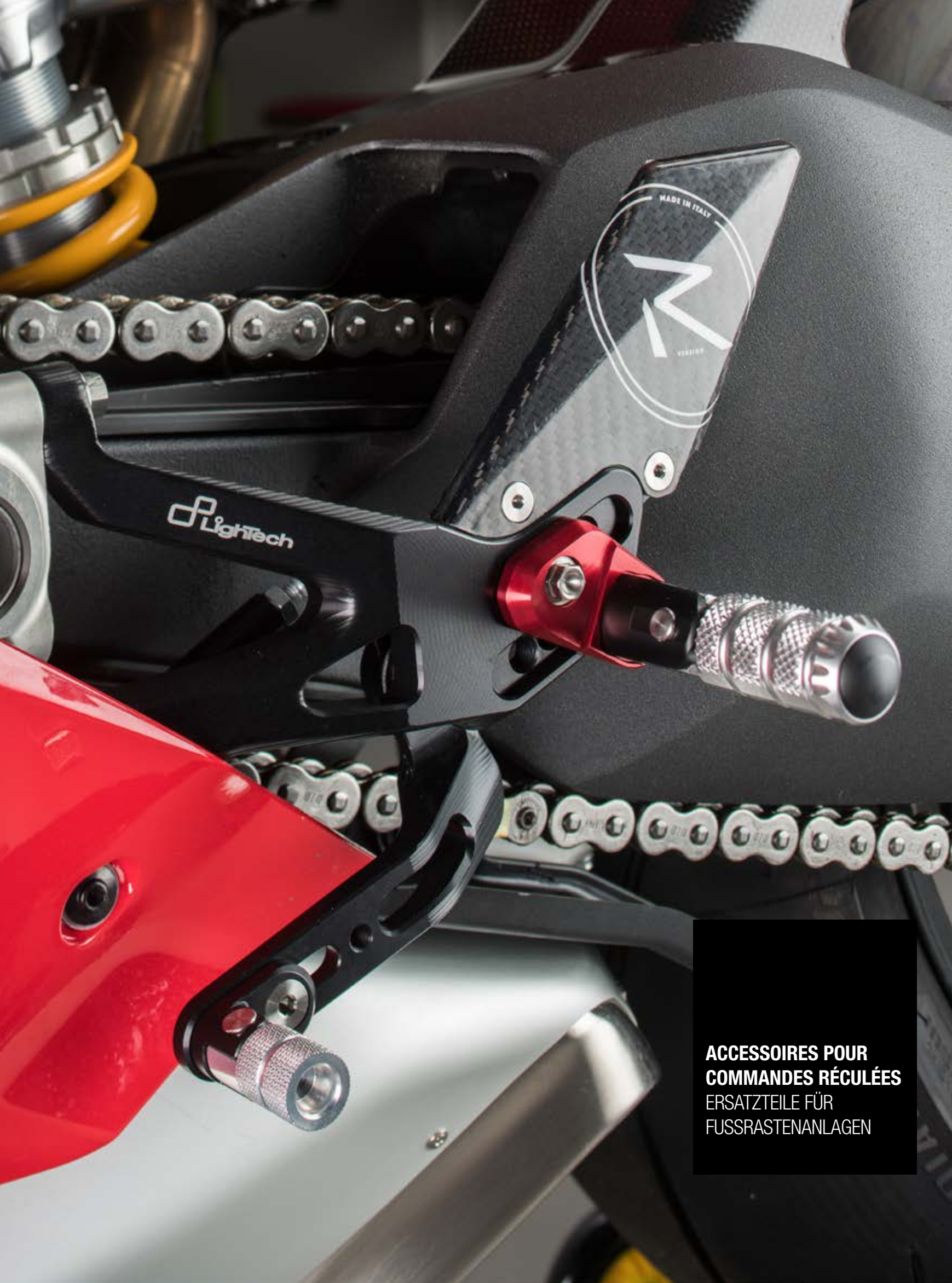

**ACCESSOIRES POUR  
COMMANDES RÉCULÉES**  
ERSATZTEILE FÜR  
FUSSRASTENANLAGEN



HIGH GRIP











Couleurs disponibles / Verfügbare Farben:



argent  
Silber

noir  
Schwarz









Repose pied fixe nicht klappbarer Rasten				Code - Code	a pièce - 1 Stück
Cales pieds fixes +visse M8x20 Feste Raste + Schrauben M8x20		+	 M8x20	=	RFTR245 € 32,10
Cales pieds fixes +visse M8x25 Feste Raste + Schrauben M8x25		+	 M8x25	=	RFTR246 € 32,10
Cales pieds fixes +visse M8x45 Feste Raste + Schrauben M8x45		+	 M8x45	=	RFTR247 € 32,10
Repose pieds fixes + Visse tête cylindrique M8x20 Feste Raste + Schrauben mit Zylinderkopt M8x20		+	 M8x20	=	RFTR248 € 32,10



! FINE DE LA SÉRIE - AUSLAUFARTIKEL

Couleurs disponibles / Verfügbare Farben:









Repose pied repliable Klappbare Fussraste		Code - Code	a pièce - 1 Stück
Repose pieds repliable + visse M8x20 Klappbare Raste + Schrauben M8X20	 +  =	RFTR249	€ 49,20
Repose pieds repliable + visse M8x25 Klappbare Raste + Schrauben M8X25	 +  =	RFTR250	€ 49,20
Repose pieds repliable + visse M8x45 Klappbare Raste + Schrauben M8X40	 +  =	RFTR251	€ 49,20
Repose pieds repliable + visse cylindrique M8x20 Klappbare Raste mit Schrauben mit Zylinderkopf M8x20	 +  =	RFTR252	€ 49,20



Couleurs disponibles / Verfügbare Farben:

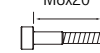

! FINE DE LA SÉRIE - AUSLAUFARTIKEL

Repose pied fixe nicht klappbarer Rasten		Code - Code	a pièce - 1 Stück
Cales pieds fixes +visse M8x20 Feste Raste + Schrauben M8x20	 +  =	RFTR189	€ 21,80
Cales pieds fixes +visse M8x25 Feste Raste + Schrauben M8x25	 +  =	RFTR45	€ 21,80
Cales pieds fixes +visse M8x45 Feste Raste + Schrauben M8x45	 +  =	RFTR32	€ 21,80
Repose pieds fixes + Visse tête cylindrique M8x20 Feste Raste + Schrauben mit Zylinderkopf M8x20	 +  =	RFTR178	€ 21,80

# ACCESSOIRES POUR COMMANDES RÉCULÉES

58 ERSATZTEILE FÜR FUSSRASTENANLAGEN



cobalt  
Kobalt



rouge  
Rot



argent  
Silber



noir  
Schwarz



vert  
Grün

Support repose pied  
Träger für Rasten

FTR704 € 29,80

a pièce - 1 Stück



rouge / Rot



argent / Silber



noir / Schwarz

Support repose pied côte frein  
Träger für Fussraste Bremsseite

FTR507 € 29,80

a pièce - 1 Stück



rouge / Rot



argent / Silber



noir / Schwarz

Support repose pied côte vitesse  
Träger für Fussraste Schaltseite

FTR508 € 29,80

a pièce - 1 Stück



cobalt / Kobalt



argent / Silber



noir / Schwarz



rouge / Rot

Kit supports pour reposepieds "UP&DOWN" qui permettent plusieurs possibilités des réglage (vis pas incluses)  
Kit Halterung für die Raste, um mehr Verstell Möglichkeiten zu haben (die Befestigungsschrauben sind nicht enthalten)

RFTR244\* € 59,50

\* Verifier compatibilité / Kompatibilität überprüfen

pour kit / kit

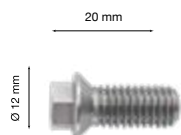

Vis pour FTR704 / RFTR244  
Schraube für FTR704 / RFTR244

FTR690 € 5,70

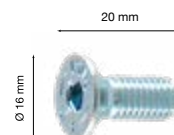

Vis pour FTR507 / FTR508  
Schraube für FTR507 / FTR508 V005M8020ZB

€ 0,80

M8 x 25

Vis de fixation des plaques des commandes reculées  
Schraube zur Befestigung der Fussrastenplatten V005M8025ZB € 0,60

M8 x 25

Vis spéciale pour la fixation des plaques des commandes reculées  
Spezialschraube zur Befestigung von Fussrastenplatten FTR760 € 6,30



Exemples de configurations possibles / Beispiele für möglichen Konfigurationen:

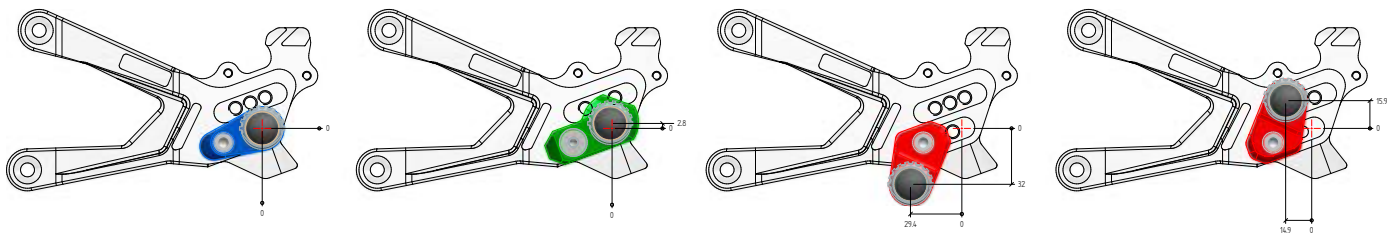



# ACCESSOIRES POUR COMMANDES RÉCULÉES

60 ERSATZTEILE FÜR FUSSRASTENANLAGEN



Protège talon en Carbone "White R"  
Fersenschützer in Carbon "White R"

FTR796 € 50,00



Protège talon en Carbone "White R"  
Fersenschützer in Carbon "White R"

FTR795 € 50,00



Protège talon en aluminium  
Fersenschützer in aluminium

FTR419SIL € 48,10



Protège talon en aluminium  
Fersenschützer in aluminium

FTR418SIL € 48,10



Protège talon en Carbone  
Fersenschützer in Carbon

FTR470 € 45,30



Protège talon en Carbone  
Fersenschützer in Carbon

FTR471 € 45,30



Protège talon en Magnésium  
Fersenschützer in Magnesium

FTR468NER € 26,40



Protège talon en Magnésium  
Fersenschützer in Magnesium

FTR469NER € 26,40



Embout selecteur articulés  
Gelenkschaltspitze RFTR154 € 38,90



Embout selecteur articulés  
Gelenkschaltspitze RFTR156 € 38,90



Embout selecteur  
Schaltspitze RFTR52 € 17,20

Aluminium



Embout selecteur articulés  
Gelenkschaltspitze RFTR213SIL € 41,30

Aluminium



Embout selecteur articulés  
Gelenkschaltspitze RFTR214SIL € 41,30



Plaque coulissant porte embout  
selecteur standard  
Unterlagscheibe für Schaltspitze FTR290 € 10,30

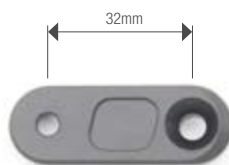

Plaque coulissant porte embout  
selecteur standard  
Unterlagscheibe für Schaltspitze FTR799 € 17,20



Strié  
Gerippt FTR236 € 33,20



Strié  
Gerippt FTR429 € 33,20



Uniball - Kugelgelenk  
Male M6 Droite / Rechts VAR1036  
Male M6 Gauche / Links VAR1077 € 9,70



Uniball - Kugelgelenk  
Female M6 Droite / Rechts VAR1095  
Female M6 Gauche / Links VAR1076 € 9,70

## ACCESSOIRES POUR COMMANDES RÉCULÉES

62 ERSATZTEILE FÜR FUSSRASTENANLAGEN



Interrupteur stop hydraulique (M10 x 1,25)  
Stopschalter hydraulisch (M10 x 1,25)

RFTR93 € 18,90



Interrupteur stop hydraulique (M10 x 1)  
Stopschalter hydraulisch (M10 x 1)

RFTR128 € 18,90

Alluminium / Aluminium

€ 18,40

mm 100	FTR741
mm 110	FTR734
mm 120	FTR742
mm 130	FTR495
mm 140	FTR518
mm 155	FTR75
mm 165	FTR252
mm 180	FTR184
mm 190	FTR62
mm 197	FTR97
mm 205	FTR163
mm 220	FTR238
mm 240	FTR32



Acier - Stahl

€ 18,40

mm 85	FTR669
mm 100	FTR666
mm 130	FTR644
mm 145	FTR546
mm 165	FTR329
mm 175	FTR228
mm 190	FTR56





**REPOSE PIEDS  
POUR COMMANDE  
RECU LÉES D'ORIGINE**  
RASTEN FÜR ORIGINALE  
FUSSRASTENANLAGE



# REPOSE PIEDS POUR COMMANDE RECLÉES D'ORIGINE

64 RASTEN FÜR ORIGINALE FUSSRASTENANLAGE VOM MOTORRADHERSTELLER



rouge  
Rot

cobalt  
Kobalt

noir  
Schwarz

or  
Gold

vert  
Grün

argent  
Silber

Repose pieds pour commande reculées d'origine Rasten für originale Fussrastenanlage vom Motorradhersteller	FTP100	pour la paire/1 Paar
		€ 57,20

Adaptateurs specific necessaire  
Spezielle Adapter sind notwendig

Modèle - Modell	Année - Jahr		Code - Code	Code - Code	€
			avant - Vordere	arrière - Hintere	pour la paire - 1 Paar

BMW					
R Nine-T /Scrambler/Pure/Urban/Racer	16	18	-	FTP029	33,20
S1000RR	15	18	FTP025	FTP026	33,20

HONDA					
CB 125R	18	22	FTP012	FTP007	33,20
CB 600 Hornet	07	13	FTP012	FTP007	33,20
CB 650 F	14	22	FTP012	FTP007	33,20
CB 1000R / ABS	08	17	FTP002	FTP007	33,20
CB 1000R	18	22	FTP012	FTP007	33,20
CBR 600F	11	14	FTP012	FTP007	33,20
CBR 600RR / ABS	03	16	FTP002	FTP007	33,20
CBR 1000RR	04	13	FTP002	FTP007	33,20
CBR 1000RR-R	20	22	-	FTP007	33,20
Integra	15	17	-	FTP007	33,20

Modèle - Modell	Année - Jahr		Code - Code		€
			avant - Vordere	arrière - Hintere	
<b>KAWASAKI</b>					
ER6 F/N	06	08	FTP003	FTP009	33,20
Z650	17	22	FTP031	FTP009	33,20
Z750/R	04	12	FTP003	FTP009	33,20
Z800	13	16	FTP003	FTP009	33,20
Z900	17	22	FTP031	FTP009	33,20
Z1000	03	09	FTP003	FTP009	33,20
Z1000	10	20	FTP004	FTP009	33,20
Z1000SX	11	20	FTP003	FTP009	33,20
ZX6-R	05	06	FTP003	FTP009	33,20
ZX6-R	07	21	FTP004	FTP009	33,20
ZX10R	08	10	FTP004	FTP009	33,20
ZX10R	11	22	-	FTP009	33,20
<b>MV</b>					
Brutale 675/800	12	16	FTP014	FTP015	33,20
Brutale 920	10	11	FTP014	FTP015	33,20
Brutale 1090-R /RR/Corsa	12	13	FTP014	FTP015	33,20
Dragster	14	16	FTP014	FTP015	33,20
F3 675/800/AGO	12	18	FTP014	FTP015	33,20
F4-S/R/RR	13	18	FTP014	FTP015	33,20
Rivale	14	16	FTP014	FTP015	33,20
Stradale	15	16	FTP014	FTP015	33,20
<b>SUZUKI</b>					
GSR600	06	10	FTP005	FTP008	33,20
GSR750	11	16	FTP005	FTP008	33,20
GSZ1300 Hayabusa	08	14	FTP005	FTP008	33,20
GSX- R600	08	17	FTP005	FTP008	33,20
GSX- R750	08	17	FTP005	FTP008	33,20
GSX- R1000	09	22	FTP005	FTP008	33,20
GSX- S125	17	21	FTP005	FTP008	33,20
GSX-S 750	17	20	FTP005	FTP008	33,20
GSX-S 1000	15	21	FTP005	FTP008	33,20
Katana	19	22	FTP005	FTP008	33,20
SFV 650 Gladius	09	14	FTP005	FTP008	33,20
<b>TRIUMPH</b>					
Speed Triple/ R	11	20	FTP010	FTP030	33,20
Street Triple/R/Daytona	11	20	FTP010	FTP030	33,20
<b>YAMAHA</b>					
FZ1/Fazer	06	12	-	FTP022	33,20
FZ8/Fazer	11	13	-	FTP022	33,20
MT-03	16	17	FTP019	-	33,20
MT-07	14	20	FTP019	FTP022	33,20
MT-09	14	20	FTP019	FTP022	33,20
MT-09	21	21	-	FTP032	33,20
MT-10	16	21	FTP019	FTP022	33,20
T-MAX	03	22	-	FTP022	33,20
YZF-R1	09	14	-	FTP021	33,20
YZF-R1	15	22	FTP027	FTP028	33,20
YZF-R3	15	22	-	FTP022	33,20
YZF-R6	06	22	FTP016	FTP021	33,20







**TENDEUR DE CHÂÎNE**  
KETTENSANNER

RAPIDE ET PRÉCIS / SCHNELL UND PRÄZISE

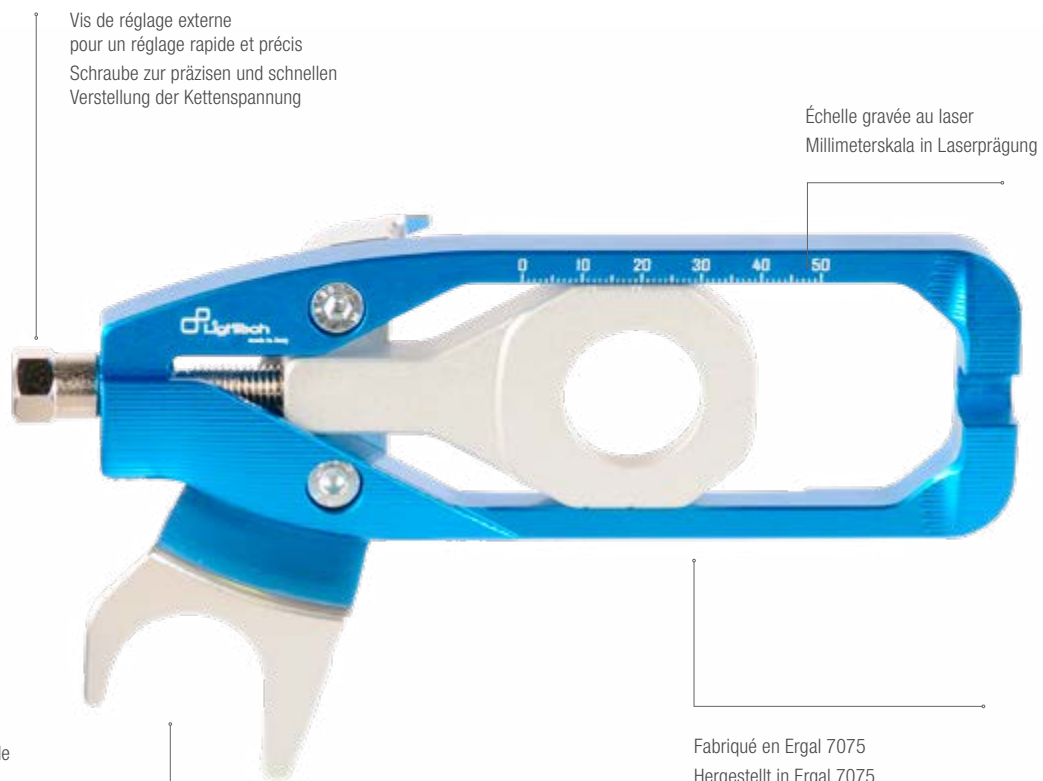

Fourchette en option pour l'utilisation de b quilles avec roulements  
Optionale Gabel zur Aufnahme f r Motorradst nder mit Rollensystem







Déplacement de 0,25 mm  
chaque clic  
Einstellschraube rastet hörbar  
in 0,25 mm Schritte



Couleur disponible / Verfügbare Farbe

- or  
Gold
- cobalt  
Kobalt
- noir  
Schwarz
- rouge  
Rot
- vert  
Grün

Modèle - Modell		Année- Jahr		Code - Code	€	
					pour la paire - 1 Paar	
<b>APRILIA</b>						
RS 660 / TUONO 660	■ ■	20	22	TEAP004	235,90	
RSV4 R / Factory / APRC	■ ■	09	14	TEAP001	218,70	
RSV4 RR / RF / APRC	■ ■	15	20	TEAP003	235,90	
RSV4 1100 Factory	■ ■	19	20	TEAP003	235,90	
RSV4 1100 Factory	■ ■	21	22	TEAP005	235,90	
Tuono V4	■ ■	11	14	TEAP001	218,70	
Tuono V4 / 1100 Factory	■ ■	15	20	TEAP003	235,90	
Tuono V4 1100	■ ■	21	22	TEAP005	235,90	
<b>BMW</b>						
S1000 R	■ ■ ■ ■	14	20	TEBM002	235,90	
S1000 R	■ ■ ■ ■	21	22	TEBM003	235,90	
S1000 RR	■ ■ ■ ■	09	18	TEBM002	235,90	
S1000 RR	■ ■ ■ ■	19	22	TEBM003	235,90	
<b>HONDA</b>						
CBR 600RR	■ ■	07	17	TEH0002	235,90	
CBR 1000RR	■ ■	08	16	TEH0002	235,90	
CBR 1000RR-R / SP	■ ■	20	22	TEH0004	274,80	
XADV	■ ■ ■	17	22	TEH0003	235,90	
<b>KAWASAKI</b>						
Z900	■ ■ ■	17	22	TEKA004	235,90	
ZX6R / 636	Nous recommandons de remplacer l'écrou d'axe de roue original par un écrou abaissé* Wir raten die Mutter der Radachse mit einer sehr niedrigen Mutter zu ersetzen*	■ ■ ■	09	21	TEKA005	235,90
ZX10R	Nous recommandons de remplacer l'écrou d'axe de roue original par un écrou abaissé* Wir raten die Mutter der Radachse mit einer sehr niedrigen Mutter zu ersetzen*	■ ■ ■	11	15	TEKA003	235,90
ZX10R	Nous recommandons de remplacer l'écrou d'axe de roue original par un écrou abaissé* Wir raten die Mutter der Radachse mit einer sehr niedrigen Mutter zu ersetzen*	■ ■ ■	16	22	TEKA002	235,90
	M 24x1,5			D024	58,40	
ÉCROU ABAISSÉ / NIEDRIGEN MUTTER *						

NEW!

NEW!

# TENDEUR DE CHAÎNE

70 KETTENSPIANNER

Modèle - Modell		Année - Jahr		Code - Code	€
					pour la paire - 1 Paar
<b>SUZUKI</b>					
GSX-R 600 / 750	■ ■ ■	11	17	TESU004	235,90
GSX-R 1000	■ ■ ■	09	16	TESU009	235,90
GSX-R 1000 / R	■ ■ ■	17	22	TESU008	235,90
GSX-S 950	■ ■ ■	21	22	TESU007	235,90
GSX-S 1000	■ ■ ■	15	22	TESU007	235,90
<b>YAMAHA</b>					
MT-09	■ ■	13	16	TEYA002	218,70
MT-09 Tracer / XSR900	■ ■	13	20	TEYA002	218,70
MT-09 / SP	■ ■ ■ ■	21	22	TEYA010	235,90
MT-10	■ ■ ■ ■	16	21	TEYA003	235,90
R1	■ ■ ■ ■	09	14	TEYA004	235,90
R1 / R1 M	■ ■ ■ ■	15	19	TEYA003	235,90
R1 / R1 M	■ ■ ■ ■	20	22	TEYA005	235,90
R6	■ ■ ■ ■	06	16	TEY608	184,40
R6	■ ■ ■ ■	17	22	TEYA006	235,90
R6 Avec support de d'étrier intégré Mit integrierter Unterstützung für Bremssattel	■ ■	17	22	TEYA008	286,20
T-MAX 530 / 560	■ ■ ■ ■	12	21	TEYA001	213,00





Tendeur de chaine avec support d'étrier de frein  
Kettenspanner mit unterstützung für bremssattel

YAMAHA R6 (2017-2022)

TEYA008

€ 286,20



Tendeur de chaine avec support d'étrier de frein  
Kettenspanner mit unterstützung für bremssattel

YAMAHA R6 (2006-2016)

TEYA608

€ 184,40





## LES AVANTAGES DES SUPPORTS ARRIÈRE RACING DIE VORTEILE DER RACING GABEL

1. Permet un usage facilité et plus rapide de la béquille de stand arrière.  
Schnelle Kupplung des Ständer.
2. Evite d'endommager le bras oscillant en cas de glissade.  
Sie kann Brüche des Motorrad Schwingarm im Fall von ausrutschen vermeiden.
3. L'utilisation de la béquille de stand à rouleau évite les rayures accidentelles.  
Beim benutzen des Rollenständer kann man Kratzer ausschliessen.

Couleurs disponibles / Verfügbare Farben:  argent  
Silber

Modèle Modell	Année Jahr		Code Code	€	Compatible avec Kompatibel mit
	pour la paire - 1 Paar				
<b>APRILIA</b>					
RS 660	20	22	FTEAP004	69,90	TEAP004
RSV4 R / FACTORY / APRC	09	14	FTEAP001	42,30	TEAP001
RSV4 RR / RF / APRC / 1100 Factory	15	20	FTEAP002	69,90	TEAP003
RSV4 1100 Factory	21	22	FTEAP005	69,90	TEAP005
TUONO V4	11	14	FTEAP001	42,30	TEAP001
TUONO V4 / 1100 Factory	15	20	FTEAP002	69,90	TEAP003
TUONO V4 / 1100 Factory	21	22	FTEAP005	69,90	TEAP005
<b>BMW</b>					
S1000 R	09	20	FTEBM002	57,20	TEBM002
S1000 R	21	22	FTEBM003	69,90	TEBM003
S1000 RR	09	18	FTEBM002	57,20	TEBM002
S1000 RR	19	22	FTEBM003	69,90	TEBM003
<b>HONDA</b>					
CBR 600 RR	07	17	FTEH002	57,20	TEH002
CBR 1000 RR	06	16	FTEH002	57,20	TEH002
CBR 1000RR-R / SP	20	22	FTEH004	69,90	TEH004
<b>KAWASAKI</b>					
ZX6R	09	20	FTEKA005	57,20	TEKA005
ZX10R	16	22	FTEKA007	69,90	TEKA002
<b>SUZUKI</b>					
GSXR 1000 / R	17	22	FTESU002	69,90	TESU008
<b>YAMAHA</b>					
R1 / R1 M	16	21	FTEYA003	57,20	TEYA004
R1	09	14	FTEYA004	57,20	TEYA004
R1 / R1 M	15	19	FTEYA003	57,20	TEYA003
R1 / R1 M	20	22	FTEYA005	69,90	TEYA005
R6	17	22	FTEYA006	69,90	TEYA006

NEW!

NEW!



FTEH0001



FTEKA0006



FTEYA0007



Modèle - Modell	Année- Jahr	Code - Code	€
<b>pour la paire - 1 Paar</b>			
<b>HONDA</b>			
CBR1000RR-R	21 22	FTEH0001	67,50
<b>KAWASAKI</b>			
ZX10R	16 22	FTEKA0006	52,70
<b>YAMAHA</b>			
MT-10	16 21	FTEYA0007	67,50
R1	15 22	FTEYA0007	67,50
R6	17 22	FTEYA0007	67,50



# SUPPORT BÉQUILLE

## NEW DESIGN, SMART PLUG

- Nouveaux supports béquille
- Disponible dans toutes les combinaisons de couleurs
- Optimisation des stocks grâce à l'interchangeabilité du CAP001 entre les séries SCV001-002 et KTM série 400 (voir page 98)
- Neue Ständeraufnahme
- In allen Farbkombinationen verfügbar
- Bestandoptimierung dank der Austauschbarkeit des CAP001 zwischen SCV001-002 und KTM 400er Serie (siehe Seite 98)

Compatible avec la nouvelle série **KTM 400**  
Austauschbare Kappe mit der neuen **KTM400 - Serie**

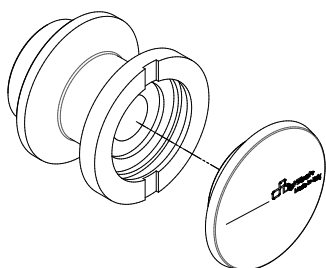

SCV001 - 002

CAP001



Mesure - Maß	Modèle - Modell		Code - Code	€
<b>pour la paire - 1 Paar</b>				
M6	Yamaha, Aprilia, Triumph, Panigale 899-959	■	SCV001	<b>13,70</b>
M8	Suzuki, Honda, Bmw, Kawasaki, Triumph 675-765	■	SCV002	<b>13,70</b>

\* Verifier compatibilité / Kompatibilität überprüfen



rouge  
Rot

cobalt  
Kobalt

noir  
Schwarz

or  
Gold

argent  
Silber

vert  
Grün

orange  
Orange

	Code - Code	€
<b>pour la paire - 1 Paar</b>		
Kit de Bouchons colorés pour SCV DE. Farbiges Kappen-Kit für SCV	CAP001	<b>12,60</b>





Mesure - Maß	Code - Code	€
		pour la paire - 1 Paar
M6	CAVM6 (Aprilia* / Ducati Panigale 899 - 959 / Yamaha*)	19,40
M8	CAVM8 (BMW* / Honda* / Kawasaki* / Suzuki* / Triumph 675 - 765)	19,40
M10 X 1,50	CAVM1015 (KTM*)	21,70
M10 x 1,25	CAVM10 (Kawasaki*)	21,70

\* Verifier compatibilité / Kompatibilität überprüfen





BORN  
TO BE  
MOTO





A close-up photograph of the handlebar and front fairing of a red and black Aprilia scooter. The image highlights the brake and clutch levers, which are red and feature the Aprilia logo. The handlebar has a black grip and a white and red lever. The front fairing is black with a red stripe and the word 'aprilia' partially visible. A red front fender is also visible. The background is a plain, light grey.

**LEVIERS**  
BREMS UND  
KUPPLUNGS HEBEL



## KIT LEVIER DE FREIN ET D'EMBRAYAGE

78 KIT KLAPPBARE BREMS UND KUPPLUNGSHABEL

### GRIP INNOVATION

- Fabriqué en magnésium pour réduire le poids
- Version "Alien" pour une meilleure adhérence
- 100% Made in Italy
- Hergestellt in Magnesium, um das Gewicht zu reduzieren
- Alien-Version für besten Halt
- 100% Made in Italy



**ALIEN**  
GRIP

avec inserts en caoutchouc  
mit Gummieinsätze

Extra grip  
100% Made in Italy  
Final Code: \_\_\_K



Extra light  
100% Made in Italy  
Final Code: \_\_\_J

KBA 91595

Couleur disponible: noir / Verfügbare Farbe: Schwarz

Modèle - Modell	TÜV KBA 91595	Année- Jahr	Code - Code	€	Code - Code	€
-----------------	---------------	-------------	-------------	---	-------------	---



APRILIA							
RS 660	NO	20	22	KLEV101J	190,10	KLEV101K	207,30
RSV1000	YES	04	09	KLEV100J	202,60	KLEV100K	219,80
RSV4 R / RR / RF / Factory / APRC	YES (09-16)	09	20	KLEV101J	190,10	KLEV101K	207,30
RSV4 1100 Factory	NO	19	22	KLEV101J	190,10	KLEV101K	207,30
TUONO V4 RR / 1100 Factory	NO	17	22	KLEV101J	190,10	KLEV101K	207,30

BMW							
S1000 R	YES	14	20	KLEV102J	190,10	KLEV102K	207,30
S1000 RR	YES	09	14	KLEV103J	190,10	KLEV103K	207,30
S1000 RR	YES	15	18	KLEV102J	190,10	KLEV102K	207,30
S1000 RR	NO	19	21	KLEV120J	202,60	KLEV120K	219,80

Modèle - Modell	TÜV KBA 91595	Année- Jahr	Code - Code	€	Code - Code	€
-----------------	---------------	-------------	-------------	---	-------------	---



DUCATI							
749 - 999	YES	02	06	KLEV104J	202,60	KLEV104K	219,80
848 - 1098 - 1198	YES	07	11	KLEV104J	202,60	KLEV104K	219,80
Diavel	YES	11	18	KLEV104J	202,60	KLEV104K	219,80
Monster 937	NO	21	22	KLEV104J	202,60	KLEV104K	219,80
Monster 1100	YES	10	13	KLEV104J	202,60	KLEV104K	219,80
Monster 1200 / R	YES (14-16)	14	20	KLEV104J	202,60	KLEV104K	219,80
Panigale 899	YES	12	16	KLEV104J	202,60	KLEV104K	219,80
Panigale 959	YES	16	21	KLEV104J	202,60	KLEV104K	219,80
Panigale 1199	YES	12	16	KLEV104J	202,60	KLEV104K	219,80
Panigale 1299	YES	15	17	KLEV104J	202,60	KLEV104K	219,80
Panigale V2	NO	20	21	KLEV104J	202,60	KLEV104K	219,80
Panigale V4 / S	YES (18-18)	18	20	KLEV104J	202,60	KLEV104K	219,80
Panigale V4 / S	NO	21	22	KLEV123J	202,60	KLEV123K	219,80
Streetfighter 848 / 1100	YES	09	16	KLEV104J	202,60	KLEV104K	219,80
Streetfighter V2	NO	21	22	KLEV123J	202,60	KLEV123K	219,80
Streetfighter V4 / S	NO	20	20	KLEV104J	202,60	KLEV104K	219,80
Streetfighter V4 / S	NO	21	22	KLEV123J	202,60	KLEV123K	219,80

HONDA							
CB 1000 R	YES	08	17	KLEV110J	202,60	KLEV110K	219,80
CB 1000 R	NO	18	20	KLEV109J	190,10	KLEV109K	207,30
CBR 600 RR	YES	07	17	KLEV109J	190,10	KLEV109K	207,30
CBR 1000 RR	YES	04	07	KLEV110J	202,60	KLEV110K	219,80
CBR 1000 RR	YES	08	19	KLEV109J	190,10	KLEV109K	207,30
CBR 1000 RR - R	NO	20	22	KLEV109J	190,10	KLEV109K	207,30
CBR 1000 RR - R SP	NO	20	22	KLEV122J	190,10	KLEV122K	207,30

KAWASAKI							
Ninja 250	NO	08	13	KLEV117J	183,20	KLEV117K	200,30
Ninja 300	YES	14	17	KLEV117J	183,20	KLEV117K	200,30
Ninja 400	YES	18	20	KLEV117J	183,20	KLEV117K	200,30
Z650	YES (17-19)	17	22	KLEV046J	183,20	KLEV046K	200,30
Z750	YES	07	12	KLEV027J	183,20	KLEV027K	200,30
Z800	YES	13	16	KLEV027J	183,20	KLEV027K	200,30
Z900	YES	17	21	KLEV046J	183,20	KLEV046K	200,30
Z1000	NO	17	20	KLEV119J	190,10	KLEV119K	207,30
Z1000 SX	NO	17	20	KLEV119J	190,10	KLEV119K	207,30
ZX6R / ZX636	YES (05-16)	05	18	KLEV105J	190,10	KLEV105K	207,30
ZX636	NO	19	21	KLEV119J	190,10	KLEV119K	207,30
ZX10R	YES	06	15	KLEV105J	190,10	KLEV105K	207,30
ZX10R	YES (16-17)	16	20	KLEV108J	190,10	KLEV108K	207,30
ZX10R	NO	21	22	KLEV125J	190,10	KLEV125K	207,30

KTM							
DUKE 790	NO	21	22	KLEV118J	202,60	KLEV118K	219,80

MV							
F3 675	YES (12-16)	12	20	KLEV114J	190,10	KLEV114K	207,30
F3 800	YES (13-16)	13	20	KLEV114J	190,10	KLEV114K	207,30

# KIT LEVIER DE FREIN ET D'EMBRAYAGE

80 KIT KLAPPBARE BREMS UND KUPPLUNGSHABEL

KBA 91595

Modèle - Modell	TÜV KBA 91595	Année- Jahr	Code - Code	€	Code - Code	€
-----------------	---------------	-------------	-------------	---	-------------	---



SUZUKI							
GSXR 600 / 750	YES	06	17	KLEV113J	190,10	KLEV113K	207,30
GSXR 1000	YES	05	06	KLEV113J	190,10	KLEV113K	207,30
GSXR 1000	YES	09	16	KLEV113J	190,10	KLEV113K	207,30
GSXR 1000 / R	YES	17	22	KLEV113J	190,10	KLEV113K	207,30
GSXS 1000	YES	15	21	KLEV113J	190,10	KLEV113K	207,30

TRIUMPH							
Daytona 675 R	YES	11	16	KLEV111J	190,10	KLEV111K	207,30
Street Triple 765 RS	NO	18	22	KLEV111J	190,10	KLEV111K	207,30
Speed Triple 1050 / 1050 R	YES	11	16	KLEV111J	190,10	KLEV111K	207,30

YAMAHA							
FZ6 / Fazer	YES	04	12	KLEV115J	183,20	KLEV115K	200,30
FZ8	YES	10	16	KLEV115J	183,20	KLEV115K	200,30
FZ1 / Fazer	YES	06	16	KLEV115J	183,20	KLEV115K	200,30
MT-07	YES (14-16)	14	20	KLEV115J	183,20	KLEV115K	200,30
MT-09 / SP	YES	13	20	KLEV115J	183,20	KLEV115K	200,30
MT-09	NO	21	22	KLEV045J	190,10	KLEV045K	207,30
MT-10	YES	16	21	KLEV115J	183,20	KLEV115K	200,30
R1	YES	04	14	KLEV107J	190,10	KLEV107K	207,30
R1 / R1-M	YES (15-16)	15	22	KLEV045J	190,10	KLEV045K	207,30
R3	NO	15	22	KLEV121J	183,20	KLEV121K	200,30
R6	YES	05	16	KLEV107J	190,10	KLEV107K	207,30
R6	YES	17	22	KLEV045J	190,10	KLEV045K	207,30
R7	NO	22	22	KLEV124J	190,10	KLEV124K	207,30
T-MAX 500 - 530 - 560	NO	08	21	KLEV116	190,10	KLEV116K	207,30
XSR 700	NO	15	20	KLEV115J	183,20	KLEV115K	200,30
XSR 900	NO	13	20	KLEV115J	183,20	KLEV115K	200,30







Couleur disponible: noir / Verfügbare Farbe: Schwarz

Modèle - Modell	TÜV KBA 91595	Année- Jahr	Code - Code	€	Code - Code	€
-----------------	---------------	-------------	-------------	---	-------------	---

**BREMBO**

BREMBO (16 x 18) (19 x 18) *	NO	-	-	LEVD502J	84,70	LEVD502K	93,30
BREMBO (19 x 20) *	NO	-	-	LEVD504J	84,70	LEVD504K	93,30

**APRILIA**

RS 660	NO	20	22	LEVD121J	112,20	LEVD121K	120,70
RSV1000	YES	04	09	LEVD121J	112,20	LEVD121K	120,70
RSV4 R / RR / RF / Factory / APRC	YES (09-16)	09	20	LEVD121J	112,20	LEVD121K	120,70
RSV4 1100 Factory	NO	19	22	LEVD121J	112,20	LEVD121K	120,70
TUONO V4 RR / 1100 Factory	NO	17	22	LEVD121J	112,20	LEVD121K	120,70

**BMW**

S1000 R	YES	14	20	LEVD126J	112,20	LEVD126K	120,70
S1000 RR	YES (09-18)	09	21	LEVD126J	112,20	LEVD126K	120,70

**DUCATI**

749 - 999	YES	02	06	LEVD110J	112,20	LEVD110K	120,70
848 - 1098 - 1198	YES	07	11	LEVD110J	112,20	LEVD110K	120,70
Diavel	YES	11	18	LEVD110J	112,20	LEVD110K	120,70
Monster 937	NO	21	22	LEVD110J	112,20	LEVD110K	120,70
Monster 1100	YES	10	13	LEVD110J	112,20	LEVD110K	120,70
Monster 1200 / R	YES (14-16)	14	20	LEVD110J	112,20	LEVD110K	120,70
Panigale 899	YES	12	16	LEVD110J	112,20	LEVD110K	120,70
Panigale 959	YES	16	20	LEVD110J	112,20	LEVD110K	120,70
Panigale 1199	YES	12	16	LEVD110J	112,20	LEVD110K	120,70
Panigale 1299	YES	15	17	LEVD110J	112,20	LEVD110K	120,70
Panigale V2	NO	20	21	LEVD110J	112,20	LEVD110K	120,70
Panigale V4 / S	YES (18-18)	18	20	LEVD110J	112,20	LEVD110K	120,70
Panigale V4 / S	NO	21	22	LEVD135J	112,20	LEVD135K	120,70
Streetfighter 848 / 1100	YES	09	16	LEVD110J	112,20	LEVD110K	120,70
Streetfighter V2	NO	21	22	LEVD135J	112,20	LEVD135K	120,70
Streetfighter V4 / S	NO	20	20	LEVD110J	112,20	LEVD110K	120,70
Streetfighter V4 / S	NO	21	22	LEVD135J	112,20	LEVD135K	120,70

\* LEV502



\* LEV504

**ONLY FOR BREMBO MODELS**

Les parts d'origine du levier Brembo sont nécessaire à l'assemblage.  
Für die Montage sind die originale Brembo Hebelteile notwendig.

# LEVIER DE FREIN ESCAMOTABLE AVEC REGLAGE À DROITE

82 VERSTELLBARE UND KLAPPBARE BREMSHEBEL

KBA 91595

Modèle - Modell	TÜV KBA 91595	Année- Jahr	Code - Code	€	Code - Code	€
-----------------	---------------	-------------	-------------	---	-------------	---



<b>HONDA</b>							
CB 1000 R	<b>YES (08-17)</b>	08	20	LEVD128J	<b>112,20</b>	LEVD128K	<b>120,70</b>
CBR 600 RR	<b>YES</b>	07	17	LEVD128J	<b>112,20</b>	LEVD128K	<b>120,70</b>
CBR 1000 RR	<b>YES</b>	04	19	LEVD128J	<b>112,20</b>	LEVD128K	<b>120,70</b>
CBR 1000 RR-R	<b>NO</b>	20	21	LEVD128J	<b>112,20</b>	LEVD128K	<b>120,70</b>
CBR 1000 RR-R SP	<b>NO</b>	20	21	LEVD110J	<b>112,20</b>	LEVD110K	<b>120,70</b>

<b>KAWASAKI</b>							
Ninja 250	<b>NO</b>	08	13	LEVD125J	<b>112,20</b>	LEVD125K	<b>120,70</b>
Ninja 300	<b>YES</b>	14	17	LEVD125J	<b>112,20</b>	LEVD125K	<b>120,70</b>
Ninja 400	<b>YES</b>	18	21	LEVD125J	<b>112,20</b>	LEVD125K	<b>120,70</b>
Z 650	<b>YES (17-19)</b>	17	22	LEVD011J	<b>112,20</b>	LEVD011K	<b>120,70</b>
Z750	<b>YES</b>	07	12	LEVD011J	<b>112,20</b>	LEVD011K	<b>120,70</b>
Z 800	<b>YES</b>	13	16	LEVD011J	<b>112,20</b>	LEVD011K	<b>120,70</b>
Z 900	<b>YES</b>	17	21	LEVD011J	<b>112,20</b>	LEVD011K	<b>120,70</b>
Z1000	<b>NO</b>	17	20	LEVD124J	<b>112,20</b>	LEVD124K	<b>120,70</b>
Z1000 SX	<b>NO</b>	17	20	LEVD124J	<b>112,20</b>	LEVD124K	<b>120,70</b>
ZX6R / ZX 636	<b>YES (05-16)</b>	05	20	LEVD124J	<b>112,20</b>	LEVD124K	<b>120,70</b>
ZX10R	<b>YES</b>	06	15	LEVD124J	<b>112,20</b>	LEVD124K	<b>120,70</b>
ZX10R	<b>YES (16-17)</b>	16	20	LEVD127J	<b>112,20</b>	LEVD127K	<b>120,70</b>
ZX10R	<b>NO</b>	21	22	LEVD137J	<b>112,20</b>	LEVD127K	<b>120,70</b>

<b>KTM</b>							
Duke 790	<b>NO</b>	18	22	LEVD132J	<b>112,20</b>	LEVD132K	<b>120,70</b>

<b>MV</b>							
F3 675	<b>YES (12-16)</b>	12	20	LEVD123J	<b>112,20</b>	LEVD123K	<b>120,70</b>
F3 800	<b>YES (13-16)</b>	13	20	LEVD123J	<b>112,20</b>	LEVD123K	<b>120,70</b>

<b>SUZUKI</b>							
GSXR 600 / 750	<b>YES</b>	04	17	LEVD123J	<b>112,20</b>	LEVD123K	<b>120,70</b>
GSXR 1000	<b>YES</b>	05	22	LEVD123J	<b>112,20</b>	LEVD123K	<b>120,70</b>
GSXS 1000	<b>YES</b>	15	21	LEVD123J	<b>112,20</b>	LEVD123K	<b>120,70</b>

<b>TRIUMPH</b>							
Daytona 675 R	<b>YES</b>	09	16	LEVD121J	<b>112,20</b>	LEVD121K	<b>120,70</b>
Street Triple 765 R / RS	<b>NO</b>	18	22	LEVD121J	<b>112,20</b>	LEVD121K	<b>120,70</b>
Speed Triple 1050 S / 1050 R	<b>YES</b>	11	16	LEVD121J	<b>112,20</b>	LEVD121K	<b>120,70</b>

<b>YAMAHA</b>							
FZ6 / Fazer	<b>YES</b>	04	16	LEVD130J	<b>112,20</b>	LEVD130K	<b>120,70</b>
FZ1 / Fazer	<b>YES</b>	06	16	LEVD130J	<b>112,20</b>	LEVD130K	<b>120,70</b>
FZ8	<b>YES</b>	10	16	LEVD130J	<b>112,20</b>	LEVD130K	<b>120,70</b>
MT-07	<b>YES (14-16)</b>	14	20	LEVD130J	<b>112,20</b>	LEVD130K	<b>120,70</b>
MT-09	<b>YES</b>	13	20	LEVD130J	<b>112,20</b>	LEVD130K	<b>120,70</b>
MT-09	<b>NO</b>	21	22	LEVD118J	<b>112,20</b>	LEVD118K	<b>120,70</b>
MT-10	<b>YES</b>	16	21	LEVD130J	<b>112,20</b>	LEVD130K	<b>120,70</b>
R1	<b>YES</b>	04	14	LEVD122J	<b>112,20</b>	LEVD122K	<b>120,70</b>
R1 / R1-M	<b>YES (15-16)</b>	15	22	LEVD118J	<b>112,20</b>	LEVD118K	<b>120,70</b>
R3	<b>YES (15-16)</b>	15	22	LEVD120J	<b>112,20</b>	LEVD120K	<b>120,70</b>
R6	<b>YES</b>	05	16	LEVD122J	<b>112,20</b>	LEVD122K	<b>120,70</b>
R6	<b>YES</b>	17	22	LEVD118J	<b>112,20</b>	LEVD118K	<b>120,70</b>
R7	<b>NO</b>	22	22	LEVD136J	<b>112,20</b>	LEVD136K	<b>120,70</b>
T-MAX 500 - 530 - 560 (RIGHT)	<b>NO</b>	08	21	LEVD133J	<b>103,00</b>	LEVD133K	<b>111,70</b>
T-MAX 500 - 530 - 560 (LEFT)	<b>NO</b>	08	21	LEVD134J	<b>103,00</b>	LEVD134K	<b>111,70</b>
XJ6	<b>YES</b>	09	16	LEVD130J	<b>112,20</b>	LEVD130K	<b>120,70</b>
XSR 700	<b>NO</b>	15	20	LEVD130J	<b>112,20</b>	LEVD130K	<b>120,70</b>
XSR 900	<b>NO</b>	13	20	LEVD130J	<b>112,20</b>	LEVD130K	<b>120,70</b>

NEW!

NEW!



Couleur disponible: noir / Verfügbare Farbe: Schwarz

Modèle - Modell	TÜV KBA 91595	Année- Jahr	Code - Code	€	Code - Code	€
						
<b>APRILIA</b>						
RS 660	NO	20	22	LEVXF001J	85,90	LEVXF001K 94,50
RSV1000	YES	04	09	LEVXF107J	98,50	LEVXF107K 107,00
RSV4 R / RR / RF / Factory / APRC	YES (09-16)	09	20	LEVXF001J	85,90	LEVXF001K 94,50
RSV4 1100 Factory	NO	19	22	LEVXF001J	85,90	LEVXF001K 94,50
TUONO V4 / RR / Factory	YES (11-16)	11	22	LEVXF001J	85,90	LEVXF001K 94,50
<b>BMW</b>						
S1000 R	YES	14	20	LEVXF015J	85,90	LEVXF015K 94,50
S1000 RR	YES	09	14	LEVXF008J	85,90	LEVXF008K 94,50
S1000 RR	YES	15	18	LEVXF015J	85,90	LEVXF015K 94,50
S1000 RR	NO	19	21	LEVXF020J	98,50	LEVXF020K 107,00
<b>DUCATI</b>						
749 - 999	YES	02	06	LEVXF107J	98,50	LEVXF107K 107,00
848 - 1098 - 1198	YES	07	11	LEVXF107J	98,50	LEVXF107K 107,00
Diavel	YES	11	16	LEVXF107J	98,50	LEVXF107K 107,00
Monster S4R	YES	07	07	LEVXF107J	98,50	LEVXF107K 107,00
Monster 937	NO	21	22	LEVXF107J	98,50	LEVXF107K 107,00
Monster 1100	YES	10	13	LEVXF107J	98,50	LEVXF107K 107,00
Monster 1200 / R	YES (14-16)	14	20	LEVXF107J	98,50	LEVXF107K 107,00
Panigale 899	YES	12	16	LEVXF107J	98,50	LEVXF107K 107,00
Panigale 959	YES	16	21	LEVXF107J	98,50	LEVXF107K 107,00
Panigale 1199	YES	12	16	LEVXF107J	98,50	LEVXF107K 107,00
Panigale 1299	YES	15	17	LEVXF107J	98,50	LEVXF107K 107,00
Panigale V4 / S	YES (18-18)	18	20	LEVXF107J	98,50	LEVXF107K 107,00
Panigale V4 / S	NO	21	22	LEVXF111J	98,50	LEVXF111K 107,00
Panigale V2	NO	20	21	LEVXF107J	98,50	LEVXF107K 107,00
Streetfighter 848 / 1100	YES	09	16	LEVXF107J	98,50	LEVXF107K 107,00
Streetfighter V2	NO	21	22	LEVXF111J	98,50	LEVXF111K 107,00
Streetfighter V4 / S	NO	20	20	LEVXF107J	98,50	LEVXF107K 107,00
Streetfighter V4 / S	NO	21	22	LEVXF111J	98,50	LEVXF111K 107,00

NEW 1

NEW 1

NEW 1



Modèle - Modell	TÜV KBA 91595	Année- Jahr	Code - Code	€	Code - Code	€
-----------------	---------------	-------------	-------------	---	-------------	---



<b>HONDA</b>							
CB 1000 R	YES	08	17	LEVXF003J	98,50	LEVXF003K	107,00
CB 1000 R	NO	18	20	LEVXF002J	85,90	LEVXF002K	94,50
CBR 600 RR	YES	03	17	LEVXF002J	85,90	LEVXF002K	94,50
CBR 1000 RR	YES	04	07	LEVXF003J	98,50	LEVXF003K	107,00
CBR 1000 RR	YES	08	19	LEVXF002J	85,90	LEVXF002K	94,50
CBR 1000 RR-R	NO	20	22	LEVXF002J	85,90	LEVXF002K	94,50
CBR 1000 RR-R / SP	NO	20	22	LEVXF002J	85,90	LEVXF002K	94,50

<b>KAWASAKI</b>							
Ninja 250	NO	08	13	LEVXF019J	85,90	LEVXF019K	94,50
Ninja 300	YES	14	17	LEVXF019J	85,90	LEVXF019K	94,50
Ninja 400	YES	18	21	LEVXF019J	85,90	LEVXF019K	94,50
Z650	YES (17-19)	17	22	LEVXF005J	85,90	LEVXF005K	94,50
Z750	YES	07	12	LEVXF004J	85,90	LEVXF004K	94,50
Z800	YES	13	16	LEVXF004J	85,90	LEVXF004K	94,50
Z900	YES	17	20	LEVXF005J	85,90	LEVXF005K	94,50
Z1000	YES	07	16	LEVXF004J	85,90	LEVXF004K	94,50
Z1000	NO	17	20	LEVXF005J	85,90	LEVXF005K	94,50
Z1000 SX	YES	11	16	LEVXF004J	85,90	LEVXF004K	94,50
ZX6R - 636	YES (05-16)	05	18	LEVXF004J	85,90	LEVXF004K	94,50
ZX636	NO	18	20	LEVXF005J	85,90	LEVXF005K	94,50
ZX10R	YES (06-19)	06	22	LEVXF004J	85,90	LEVXF004K	94,50

<b>KTM</b>							
DUKE 790	NO	18	20	LEVXF109J	98,50	LEVXF109K	107,00

<b>MV</b>							
F3 675	YES (12-16)	12	20	LEVXF012J	85,90	LEVXF012K	94,50
F3 800	YES (13-16)	13	20	LEVXF012J	85,90	LEVXF012K	94,50

<b>SUZUKI</b>							
GSXR 600 / 750	YES	06	17	LEVXF001J	85,90	LEVXF001K	94,50
GSXR 1000	YES	05	06	LEVXF001J	85,90	LEVXF001K	94,50
GSXR 1000	YES	09	22	LEVXF001J	85,90	LEVXF001K	94,50
GSXS 1000	YES	15	21	LEVXF001J	85,90	LEVXF001K	94,50

<b>TRIUMPH</b>							
Daytona 675	YES	06	14	LEVXF018J	85,90	LEVXF018K	94,50
Daytona 675R	YES	11	16	LEVXF018J	85,90	LEVXF018K	94,50
Street Triple 675 R	YES (08-16)	08	17	LEVXF018J	85,90	LEVXF018K	94,50
Street Triple 765 R / RS	NO	18	20	LEVXF018J	85,90	LEVXF018K	94,50
Speed Triple 1050 S / 1050R	YES	11	16	LEVXF018J	85,90	LEVXF018K	94,50

<b>YAMAHA</b>							
FZ6 / Fazer	YES	04	16	LEVXF001J	85,90	LEVXF001K	94,50
FZ8	YES	10	16	LEVXF001J	85,90	LEVXF001K	94,50
FZ1 / Fazer	YES	06	16	LEVXF001J	85,90	LEVXF001K	94,50
MT-07	YES (14-16)	14	20	LEVXF001J	85,90	LEVXF001K	94,50
MT-09	YES	13	22	LEVXF001J	85,90	LEVXF001K	94,50
MT-10	YES	16	20	LEVXF001J	85,90	LEVXF001K	94,50
R3	NO	15	22	LEVXF021J	85,90	LEVXF021K	94,50
R6	YES	00	22	LEVXF001J	85,90	LEVXF001K	94,50
R1 / R1-M	YES (00-16)	00	22	LEVXF001J	85,90	LEVXF001K	94,50
XJ6	YES	09	16	LEVXF001J	85,90	LEVXF001K	94,50
XSR 700	NO	15	20	LEVXF001J	85,90	LEVXF001K	94,50
XSR 900	NO	13	20	LEVXF001J	85,90	LEVXF001K	94,50

**NEW LOOK, BEST COMFORT**

Nouveau levier d'embrayage rabattable à empattement variable. Né pour une utilisation en course, il vous permet de faire varier l'empattement moteur.

Avec cette mise à jour, le conducteur peut gérer le desserrage de l'embrayage, ce qui signifie qu'il peut perfectionner les démarrages et personnaliser la course du levier.

Neuer Klappkupplungshebel mit variablem Radstand. Es wurde für den Renneinsatz entwickelt und ermöglicht es Ihnen, den Radstand des Antriebs zu variieren. Mit dieser Aktualisierung kann der Fahrer die Kupplungsfreigabe verwalten, was bedeutet, dass der Fahrer die Starts perfektionieren und den Hebelhub anpassen kann.



Empattements de 30/32/344 mm. le système de fermeture du joint est encore plus rapide grâce à la sangle de fermeture avec le système de charnière.

Radstände von 30/32/34 mm. Das Schließsystem des Gelenks ist dank des Schließbandes mit dem Scharniersystem noch schneller.

Couleur disponible: noir. Verfügbare Farbe: Schwarz

Modèle - Modell	Code - Code	€	Code - Code	€
<b>FOR RACING USE ONLY</b>				
		<b>J</b>		<b>K</b>
Levier d'embrayage à câble à empattement variable Kabelkupplungshebel mit variablem Radstand	LEVXF100J	174,00	LEVXF100K	182,60



## LEVIER DE FREIN ESCAMOTABLE AVEC REGLAGE À GAUCHE

86

KLAPPBARE BREMSHEBEL MIT MONTAGEKIT ZUR VERSTELLUNG AUF DER LINKEN SEITE



Couleur disponible: noir. Verfügbare Farbe: Schwarz

Modèle - Modell	TUV KBA 91595	Année- Jahr	Code - Code	€	Code - Code	€	
<b>BREMBO</b>							
* BREMBO (16 x 18) (19 x 18)	NO	-	-	LEVS502J	148,80	LEVS502K	157,50
* BREMBO (19 x 20)	NO	-	-	LEVS504J	148,80	LEVS504K	157,50
<b>APRILIA</b>							
RS 660	NO	20	22	LEVS121J	203,80	LEVS121K	212,30
RSV1000	YES	04	09	LEVS121J	203,80	LEVS121K	212,30
RSV4 R / RR / RF / Factory / APRC	YES (09-16)	09	22	LEVS121J	203,80	LEVS121K	212,30
RSV4 1100 Factory	NO	19	22	LEVS121J	203,80	LEVS121K	212,30
<b>BMW</b>							
S1000 RR	YES (09-18)	09	21	LEVS126J	203,80	LEVS126K	212,30
<b>DUCATI</b>							
749 - 999	YES	02	06	LEVS110J	203,80	LEVS110K	212,30
848 - 1098 - 1198	YES	07	11	LEVS110J	203,80	LEVS110K	212,30
Panigale 899	YES	12	16	LEVS110J	203,80	LEVS110K	212,30
Panigale 959	YES	16	21	LEVS110J	203,80	LEVS110K	212,30
Panigale 1199	YES	12	16	LEVS110J	203,80	LEVS110K	212,30
Panigale 1299	YES	15	17	LEVS110J	203,80	LEVS110K	212,30
Panigale V4 / S	YES (18-18)	18	20	LEVS110J	203,80	LEVS110K	212,30
Panigale V4 / S	NO	21	22	LEVS135J	203,80	LEVS135K	212,30
Panigale V2	NO	20	21	LEVS110J	203,80	LEVS110K	212,30
<b>HONDA</b>							
CBR 600 RR	YES	07	17	LEVS128J	203,80	LEVS128K	212,30
CBR 1000 RR	YES	04	19	LEVS128J	203,80	LEVS128K	212,30
CBR 1000 RR-R	NO	20	22	LEVS128J	203,80	LEVS128K	212,30
CBR 1000 RR-R SP	NO	20	22	LEVS110J	203,80	LEVS110K	212,30
<b>KAWASAKI</b>							
ZX6R	YES (05-16)	05	20	LEVS124J	203,80	LEVS124K	212,30
ZX10R	YES	06	15	LEVS124J	203,80	LEVS124K	212,30
ZX10R	YES (16-17)	16	20	LEVS127J	203,80	LEVS127K	212,30
ZX10R	NO	21	22	LEVS137J	203,80	LEVS137K	212,30

\* Les parts d'origine du levier Brembo sont nécessaire à l'assemblage.  
Für die Montage sind die originale Brembo Hebelteile notwendig.



# LEVIER DE FREIN ESCAMOTABLE AVEC REGLAGE À GAUCHE

## KLAPPBARE BREMSHEBEL MIT MONTAGEKIT ZUR VERSTELLUNG AUF DER LINKEN SEITE

Modèle - Modell	TÜV KBA 91595	Année- Jahr	Code - Code	€	Code - Code	€
						
<b>MV</b>						
F3 675	YES (12-16)	12	20	LEVS123J	203,80	LEVS123K 212,30
F3 800	YES (13-16)	13	20	LEVS123J	203,80	LEVS123K 212,30
<b>SUZUKI</b>						
GSXR 600 / 750	YES	04	17	LEVS123J	203,80	LEVS123K 212,30
GSXR 1000	YES	05	22	LEVS123J	203,80	LEVS123K 212,30
<b>TRIUMPH</b>						
Daytona 675 R	YES	09	16	LEVS121J	203,80	LEVS121K 212,30
<b>YAMAHA</b>						
R1 / R1-M	YES (15-16)	15	22	LEVS118J	203,80	LEVS118K 212,30
R3	YES (15-16)	15	22	LEVS120J	203,80	LEVS120K 212,30
R6	YES	05	16	LEVS122J	203,80	LEVS122K 212,30
R6	YES	17	22	LEVS118J	203,80	LEVS118K 212,30
R1	YES	04	14	LEVS122J	203,80	LEVS122K 212,30
R7	NO	22	22	LEVS136J	203,80	LEVS136K 212,30



### INSERTS EN CAOUTCHOUC POUR LEVIER "ALIEN"

### GUMMIEINSÄTZE FÜR HEBEL "ALIEN"



- rouge  
Rot
- bleu  
Blau
- noir  
Schwarz
- blanc  
Weiss
- vert  
Grün
- orange  
Orange

Modèle - Modell	Code - Code	Code - Code	Code - Code	Code - Code	Code - Code	Code - Code	€
							
Kit d'inserts en caoutchouc pour une levier "Alien" (une bande) Gummieinsatz-Kit für einen einzelnen Hebel „Alien“ (ein Streifen)	GM001ROS	GM001VER	GM001BLU	GM001NER	GM001BIA	GM001ARA	4,50



Levier en magnésium  
Hebel aus magnesium

RLEV001J € 53,80

Couleur disponible: noir. Verfügbare Farbe: Schwarz



Levier "Alien" en magnésium avec inserts en caoutchouc noir  
"Alien" Hebel aus Magnesium mit schwarzen Gummeinsätzen

RLEV001K € 62,40

Couleur disponible: noir. Verfügbare Farbe: Schwarz



Molette de réglage pour levier de frein avec support  
Ersatzteil für Links Verstellung ohne Kabel

RLEV015 € 100,80



CABLE DE RÉGLAGE  
ERSATZTKABEL

A (M7)	RLEV008	€ 19,40
B	RLEV014	€ 19,40
C	RLEV009	€ 19,40
D (M6)	RLEV017	€ 19,40







**SUPPORT**  
**DEMI GUIDON**  
LENKERSCHELLEN



# SUPPORT DEMI GUIDON

90 LENKERSCHELLEN

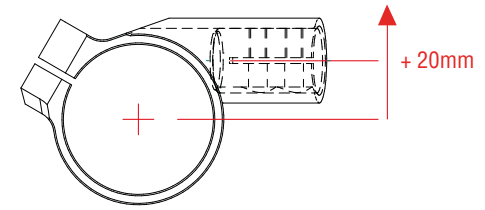

**Bracelets de guidons avec décalage +20 mm**  
Lenkerschellen mit Offset +20mm

Couleur disponible: noir. Verfügbare Farbe: Schwarz

Ø	Hauteur - Höhe	° inclinaison - ° Winkel	décalage - Offset	Code - Code	€
					<b>pour la paire/1 Paar</b>
Ø 41	+/- 0mm	10°	+ 20mm	MOZ4101	<b>160,30</b>
Ø 47	+/- 0mm	10°	+ 20mm	MOZ4701	<b>160,30</b>
Ø 50	+/- 0mm	10°	+ 20mm	MOZ5001	<b>160,30</b>
Ø 51	+/- 0mm	10°	+ 20mm	MOZ5101	<b>160,30</b>
Ø 52	+/- 0mm	10°	+ 20mm	MOZ5201	<b>160,30</b>
Ø 53	+/- 0mm	10°	+ 20mm	MOZ5301	<b>160,30</b>
Ø 54,5	+/- 0mm	10°	+ 20mm	MOZ5401	<b>160,30</b>
Ø 55	+/- 0mm	10°	+ 20mm	MOZ5501	<b>160,30</b>

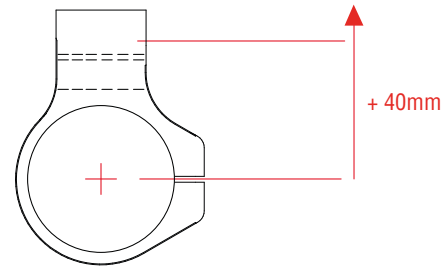

**Bracelets de guidons avec décalage +40 mm**  
Lenkerschellen mit Offset +40mm

Couleur disponible: noir. Verfügbare Farbe: Schwarz

Ø	Hauteur - Höhe	° inclinaison - ° Winkel	décalage - Offset	Code - Code	€
					<b>pour la paire/1 Paar</b>
Ø 47	+/- 0mm	10°	+ 40mm	MOZ4710	<b>196,90</b>
Ø 48	+/- 0mm	10°	+ 40mm	MOZ4810	<b>196,90</b>
Ø 50	+/- 0mm	10°	+ 40mm	MOZ5010	<b>196,90</b>
Ø 51	+/- 0mm	5°	+ 40mm	MOZ5110	<b>196,90</b>
Ø 52	+/- 0mm	5°	+ 40mm	MOZ5210	<b>196,90</b>
Ø 53	+/- 0mm	10°	+ 40mm	MOZ5310	<b>196,90</b>
Ø 54,5	+/- 0mm	10°	+ 40mm	MOZ5410	<b>196,90</b>
Ø 55	+/- 0mm	5°	+ 40mm	MOZ5510	<b>196,90</b>

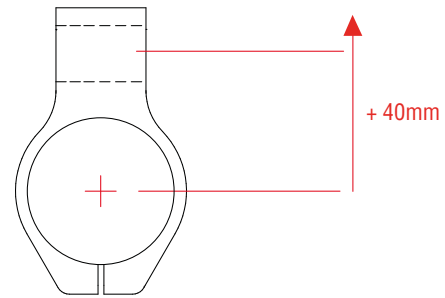

Bracelets de guidons avec décalage +40 mm  
Lenkerschellen mit Offset +40mm

Couleur disponible: noir. Verfügbare Farbe: Schwarz

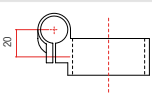
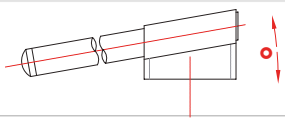
Ø	Hauteur - Höhe	° inclinaison - ° Winkel	décalage - Offset	Code - Code	€
					
					<b>pour la paire/1 Paar</b>
Ø 47	+20mm	10°	+ 40mm	MOZ4720	<b>208,30</b>
Ø 48	+20mm	10°	+ 40mm	MOZ4820	<b>208,30</b>
Ø 50	+20mm	10°	+ 40mm	MOZ5020	<b>208,30</b>
Ø 55	+20mm	5°	+ 40mm	MOZ5520	<b>208,30</b>

Application support demi guidons - Verwendungsliste Lenkerschellen

Modèle - Modell	Année - Jahr	diamètre - Durchmesser
<b>APRILIA</b>		
RS660	20	22
RSV 1000	00	05
RSV 1000 / Factory	06	09
RSV4 R / RR	09	20
RSV4 Factory / APRC / RF	09	18
RSV4 1100 Factory	19	22
<b>BMW</b>		
S 1000 RR	09	22
<b>DUCATI</b>		
748-749-916-998-999	94	06
848 / 1098 / 1198	07	11
Panigale V2	20	22
Panigale V4	18	22
<b>HONDA</b>		
CBR 600 RR	07	16
CBR 1000 RR	04	19
CBR 1000 RR-R / SP	20	22
<b>KAWASAKI</b>		
ZX 400	18	21
ZX 6 R	03	08
ZX 6 R	09	17
ZX 636	09	21
ZX 10 R	04	22
<b>MV AUGUSTA</b>		
F3 675 / F3 800	12	16
<b>SUZUKI</b>		
GSXR 600/750	06	07
GSXR 600/750	08	17
GSXR 1000	05	22
<b>TRIUMPH</b>		
Daytona 675 / 675 R	07	18
Daytona 765	19	20
<b>YAMAHA</b>		
R3	16	18
R3	19	22
R6	06	22
R1 / R1M	04	22

## SUPPORT DEMI GUIDON

92 LENKERSCHELLEN



DEMI GUIDON - LENKERSTUMMEL	Code - Code	€
		pour la paire/1 Paar
Longueur 270 mm - Länge 270 mm trou intérieur ø 16.5 mm - inneres Loch ø 16.5 mm	HBT004	46,60



Bracelets triple pince pour BMW S1000RR 19 - 22

TCB001NER

€ 67,80

Dreifachklemmarmbänder für BMW S1000RR 19 - 22







**PROTECTION  
LEVIERS**  
HEBELPROTEKTOR

100%  
Made in Italy



**ATTENTION!**

- L'adaptateur est absolument nécessaire afin d'appliquer la protection levier

**ACHTUNG!**

- Der Adapter ist absolut notwendig, um die Hebelprotektor einzubauen



Protections de levier  
Hebelprotektor

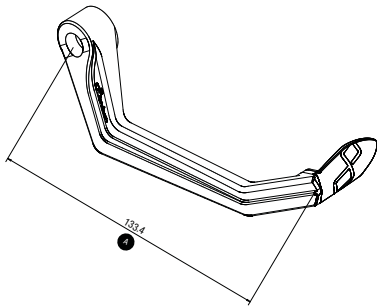

Vérifiez toujours la mesure  
Überprüfen Sie immer die Messung

- vert / Grün
- or / Gold
- rouge / Rot
- noir / Schwarz
- argent / Silber
- cobalt / Kobalt
- orange / Orange

Description - Beschreibung	A	Code - Code	€			
			<b>a pièce - 1 Stück</b>			
<b>Protection de levier en Aluminium (Corps + retour de finition, sans adaptateurs) / HEBELPROTEKTOR aus Aluminium (Hebel + Endstück, ohne Adapter)</b>						
Protection de levier de frein / Bremshebelprotektor aus Aluminium	R	132 mm	ISS113RA	(corps+retour de finition / Hebel+Endstück)	121,40	
Protection de levier de frein / Bremshebelprotektor aus Aluminium	R	148 mm	ISS120RA	(corps+retour de finition / Hebel+Endstück)	121,40	
Protection d'levier d'embrayage / Kupplungshebelprotektor aus Aluminium	L	132 mm	ISS119LA	(corps+retour de finition / Hebel+Endstück)	121,40	
Protection d'levier d'embrayage / Kupplungshebelprotektor aus Aluminium	L	148 mm	ISS114LA	(corps+retour de finition / Hebel+Endstück)	121,40	





Description - Beschreibung	A	Code - Code	€
<b>a pièce - 1 Stück</b>			
Protection de levier en Carbone ( <b>Corps + retour de finition, sans adaptateur</b> ) / Bremshebelprotektor aus Carbon ( <b>Hebel+Endstück ohne Adapter</b> )			
Protection de levier de frein / Bremshebelprotektor aus Carbon	R	132 mm	ISS115RC ( <b>corps+retour de finition / Hebel+Endstück</b> )
Protection de levier d'embrayage / Kupplungshebelprotektor aus Carbon	L	132 mm	ISS116LC ( <b>corps+retour de finition / Hebel+Endstück</b> )

**PIÈCES DÉTACHÉES POUR LES PROTECTIONS DE LEVIER**  
ERSATZTEILE FÜR HEBELPROTEKTOR

Couleurs disponibles / Verfügbare Farben:



vert Grün      or Gold      rouge Rot      noir Schwarz      argent Silber      cobalt Kobalt      orange Orange

Description - Beschreibung	A	Code - Code	€
<b>a pièce - 1 Stück</b>			
Terminale Retour de finition R / Endstück R	R	ISS117	45,30
Terminale Retour de finition L / Endstück L	L	ISS118	45,30



# ADAPTATEURS PROTECTION LEVIERS

96 ADAPTER FÜR HEBELPROTEKTOR



**Attention!** L'adaptateur est absolument nécessaire afin d'appliquer la protection levier.

**Bitte beachten:** der Adapter ist absolut notwendig um den Protektor einzubauen.

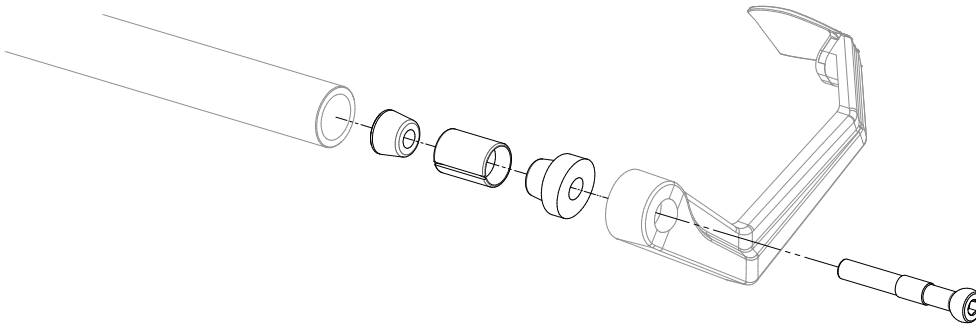

Description - Beschreibung	Année- Jahr	Ø	Code - Code	€
----------------------------	-------------	---	-------------	---

					a pièce - 1 Stück
adaptateurs universels / Universaladapter			14/15,5	KPL329	27,40
adaptateurs universels spécifiques pour HBT004 / Universaladapter spezifisch für HBT004			16/17,5	KPL302	27,40
adaptateurs universels / Universaladapter			18/19,5	KPL319	27,40

<b>APRILIA</b>					
RS 660	20	22		KPL331	27,40
RSV4 (all versions)	09	22		KPL303	27,40
RSV1000	04	08		KPL313	27,40
Shiver 750	07	15		KPL313	27,40
Tuono	06	09		KPL313	27,40
Tuono V4 / 1100 Factory	11	22		KPL313	27,40

<b>BMW</b>					
R Nine-T Scrambler / Pure / Urban / Racer	16	16		KPL325	27,40
S1000R	14	20		KPL325	27,40
S1000RR	09	18		KPL325	27,40
S1000RR	19	22		KPL330	27,40

<b>DUCATI</b>					
1098 / 1198	07	11	16/17,5	KPL302	27,40
Monster S4 - ST2	07	07		KPL304	27,40
Monster 821	14	16	17	KPL302	27,40
Monster 937	21	22		KPL302	27,40
Monster 1100	11	13	14,5	KPL322	27,40
Panigale 899 / 1199 / 1299	12	17		KPL318	27,40
Panigale 959	16	20		KPL318	27,40
Panigale V2 955	20	22		KPL318	27,40
Panigale V4	18	22	18	KPL319	27,40
Streetfighter 848 / 1100	08	16	14,5	KPL322	27,40
Streetfighter V4	20	22	14,5	KPL322	27,40

<b>HONDA</b>					
tous / alle	....	....		KPL306	27,40

<b>KAWASAKI</b>					
ER-6N	12	15		KPL304	27,40
Ninja 250 / Ninja 400	18	22		KPL304	27,40
Z750	04	12		KPL304	27,40
Z650	17	20		KPL319	27,40
Z800	13	16		KPL304	27,40

Description - Beschreibung	Année- Jahr		Ø	Code - Code	€
					a pièce - 1 Stück
<b>KAWASAKI</b>					
Z900	17	22		KPL304	27,40
Z1000	03	16		KPL304	27,40
Z1000 SX	11	16		KPL304	27,40
ZX250R	09	12		KPL304	27,40
ZX6R / 636	03	21		KPL304	27,40
ZX10R	11	22		KPL304	27,40
<b>KTM</b>					
Duke 125 / 390	17	21		KPL311	27,40
Duke 790	18	21		KPL329	27,40
Duke 890 R	20	22		KPL329	27,40
Duke 1290 R	20	22		KPL329	27,40
<b>MV</b>					
BRUTALE 4 cilindri (all versions)	10	17	16/17,5	KPL302	27,40
B3 675 / 800	12	17		KPL320	27,40
F3 675 / 800	11	17	18/19,5	KPL319	27,40
F4 (all versions)	10	17	18/19,5	KPL323	27,40
<b>SUZUKI</b>					
Gladius 650	09	15		KPL309	27,40
GSR 600	06	11		KPL305	27,40
GSR 750	11	16		KPL305	27,40
GSXR 600 / 750	00	05		KPL305	27,40
GSXR 600 / 750	06	17		KPL309	27,40
GSXR 1000	03	04		KPL305	27,40
GSXR 1000	05	16		KPL309	27,40
GSXR 1000	17	22		KPL327	27,40
GSXS 750	17	20		KPL328	27,40
GSXS 1000	15	21		KPL302	27,40
<b>TRIUMPH</b>					
STREET TRIPLE 675 R	07	12		KPL302	27,40
STREET TRIPLE 675 R	13	16		KPL311	27,40
STREET TRIPLE 765 R / S / RS	17	22		KPL311	27,40
<b>YAMAHA</b>					
Fazer 600 - FZ6	04	06		KPL310	27,40
Fazer 1000	01	12		KPL310	27,40
MT-07	14	20		KPL310	27,40
MT-09	13	20		KPL310	27,40
MT-09	21	22		KPL311	27,40
MT-10	16	21		KPL310	27,40
R 125	08	17		KPL310	27,40
R1 / R1M	98	22		KPL311	27,40
R3	15	22		KPL311	27,40
R6	06	22		KPL311	27,40
T Max 500 - 530 - 560	02	21		KPL310	27,40
X-Max 400	13	19		KPL310	27,40

# ADAPTATEURS PROTECTION LEVIERS

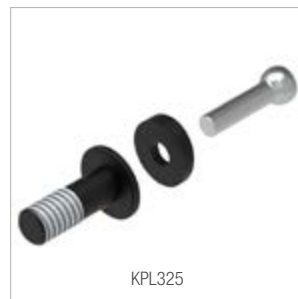





**EMBOUTS  
DE GUIDON**  
STRUKTURIERTE  
LENKERGEWICHTE

# EMBOUS DE GUIDON

## 100 STRUKTURIERTE LENKERGEWICHTE



### CAP001

Disponible dans toutes les combinaisons de couleurs  
In allen Farbkombinationen verfügbar

### NEW DESIGN, SMART PLUG

Optimisation des stocks grâce à l'interchangeabilité du **CAP001** entre KTM série 400 et **SCV001-002** (voir page 72).

Bestandoptimierung dank der Austauschbarkeit des **CAP001** zwischen der KTM 400er Serie und **SCV001-002** (siehe Seite 72).

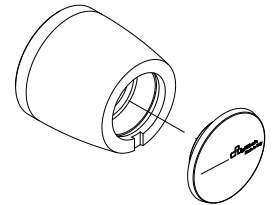

a kit - 1 kit

FR. Kit de Bouchons colorés pour la série KTM 400  
Farbiges Kappen-Kit für die KTM 400-Serie

CAP001

€ 12,60

### KTM 400 series

Couleur disponible: noir / Verfügbare Farbe: Schwarz

Description - Beschreibung	Année- Jahr		Mesure - Maß	Code - Code	€
	du - von	au - bis			
Universel / Universal			d.12/13/17	KTM400	<b>30,90</b>
<b>APRILIA</b>					
RS 660	20	22		KTM431	<b>27,40</b>
RSV4 (all versions)	09	22		KTM403	<b>27,40</b>
<b>BMW</b>					
R Nine-T / Scrambler / Pure / Urban / Racer	16	19		KTM425	<b>27,40</b>
S1000R	14	20		KTM425	<b>27,40</b>
S1000RR	09	18		KTM425	<b>27,40</b>
S1000RR	19	22		KTM430	<b>27,40</b>
<b>DUCATI</b>					
Diavel	11	18	d.12	KTM400	<b>30,90</b>
Monster 821	14	20	d.17	KTM400	<b>30,90</b>
Monster 1200 S / R	17	20		KTM400	<b>30,90</b>
Multistrada	03	09		KTM405	<b>27,40</b>
Panigale 899 / 1199 / 1299	12	17		KTM418	<b>27,40</b>
Panigale 959	16	20		KTM418	<b>27,40</b>
Panigale V2 955	20	22		KTM418	<b>27,40</b>
Panigale V4 / V4 S / V4 R / Speciale	18	22		KTM429	<b>27,40</b>
Streetfighter V2	21	22	d.13	KTM400	<b>30,90</b>
Streetfighter V4 / S	20	22		KTM422	<b>27,40</b>
848	08	11	d.12	KTM400	<b>30,90</b>
1098 / 1198	07	11	d.17	KTM400	<b>30,90</b>
<b>HONDA</b>					
tous / alle	-	-		KTM406	<b>27,40</b>

Description - Beschreibung	Année- Jahr		Mesure - Maß	Code - Code	€
	du - von	au - bis			
<b>KAWASAKI</b>					
ER-6N	12	16		KTM404	27,40
Ninja 250 / Ninja 400	18	21		KTM404	27,40
Z125	19	20		KTM404	27,40
Z400	17	21		KTM404	27,40
Z650	17	20		KTM426	27,40
Z750	04	12		KTM404	27,40
Z800	13	16		KTM407	27,40
Z900	17	22		KTM404	27,40
Z1000	03	16		KTM404	27,40
Z1000 SX	11	16		KTM404	27,40
ZX250R	09	12		KTM407	27,40
ZX6R / 636	03	20		KTM404	27,40
ZX10R	11	15		KTM404	27,40
ZX10R	16	22		KTM407	27,40
<b>KTM</b>					
Duke 390	17	21		KTM411	27,40
Duke 790	18	22		KTM400	30,90
Duke 890 R	20	22		KTM400	30,90
Duke 1290R	20	22		KTM400	30,90
<b>SUZUKI</b>					
Gladius 650	09	15		KTM409	27,40
GSR 600	06	11		KTM405	27,40
GSR 750	11	16		KTM405	27,40
GSXR 600 / 750	00	05		KTM405	27,40
GSXR 600 / 750	06	16		KTM409	27,40
GSXR 1000	03	04		KTM405	27,40
GSXR 1000	05	16		KTM409	27,40
GSXR 1000	17	22		KTM427	32,10
GSXR 750	17	21		KTM428	27,40
GSXS 1000	15	21		KTM400	30,90
<b>TRIUMPH</b>					
Street Triple 675	07	12		KTM400	30,90
Street Triple 675 R	13	16		KTM411	27,40
Street Triple 765 R / S / RS	17	22		KTM411	27,40
<b>YAMAHA</b>					
Fazer 600 - FZ6	04	06		KTM410	27,40
FZ1	06	11		KTM411	27,40
Fazer 1000	01	12		KTM410	27,40
MT-07 / XSR-700	14	20		KTM410	27,40
MT-09 / SP	13	20		KTM410	27,40
MT-09 / SP	21	22		KTM411	27,40
MT-10	16	21		KTM410	27,40
R 125	08	13		KTM410	27,40
R1	98	22		KTM411	27,40
R3	15	22		KTM411	27,40
R6	06	22		KTM411	27,40
R7	22	22		KTM411	27,40
T Max 500 - 530 - 560	02	21		KTM410	27,40
X-Max 400	13	19		KTM410	27,40





# EMBOUTS DE GUIDON



cobalt  
Kobalt

rouge  
Rot

vert  
Grün

or  
Gold

noir  
Schwarz

argent  
Silber

orange  
Orange

Modèle - Modell	Année- Jahr		Mesure - Maß	Combinaisons de couleurs - Farbkombinationen	Code - Code	€
-----------------	-------------	--	--------------	--	-------------	---

	du - von	au - bis				
Universel / Universal			d.12/13/17		KTM300	43,50

<b>APRILIA</b>						
RSV4 (all versions)	09	22			KTM303	41,80
RSV1000	04	08			KTM313	41,80
Shiver 750	07	16			KTM313	41,80
Tuono	06	09			KTM313	41,80
Tuono V4	11	20			KTM313	41,80

<b>BMW</b>						
R Nine-T / Scrambler / Pure / Urban / Racer	16	19			KTM325	41,80
S1000R	14	20			KTM325	41,80
S1000RR	09	18			KTM325	41,80
S1000RR	19	22			KTM330	41,80

<b>DUCATI</b>						
Diavel	11	18	d.12		KTM300	43,50
Monster 821	14	20	d.17		KTM300	43,50
Monster 1100	11	13	d.14,5		KTM322	41,80
Monster 1200 S / R	17	20			KTM300	43,50
Multistrada	03	09			KTM305	41,80
Panigale 899 / 1199 / 1299	12	17			KTM318	41,80
Panigale 959	16	20			KTM318	41,80
Panigale V2 955	20	22			KTM318	41,80
Panigale V4 / V4 S / V4 R / Speciale	18	22			KTM329	41,80
Streetfighter 848 / 1100	08	16	d.14,5		KTM322	41,80
Streetfighter V2	21	22	d.13		KTM300	43,50
Streetfighter V4 / S	20	22	d.14,5		KTM322	41,80
848	08	11	d.12		KTM300	43,50
1098 / 1198	07	11	d.17		KTM300	43,50

<b>HONDA</b>						
tous / alle	...	...			KTM306	41,80

<b>KAWASAKI</b>						
ER-6N	12	16			KTM304	41,80
Ninja 250 / Ninja 400	18	21			KTM304	41,80
Z125	19	20			KTM304	41,80
Z400	17	21			KTM304	41,80
Z650	17	20			KTM326	43,50
Z750	04	12			KTM304	41,80
Z800	13	16			KTM307	41,80
Z900	17	22			KTM304	41,80
Z1000	03	16			KTM304	41,80
Z1000 SX	11	16			KTM304	41,80
ZX250R	09	12			KTM307	41,80
ZX6R / 636	03	20			KTM304	41,80
ZX10R	11	15			KTM304	41,80
ZX10R	16	22			KTM307	41,80

Modèle - Modell	Année- Jahr		Mesure - Maß	Combinaison de couleurs - Farbkombination	Code - Code	€
	du - von	au - bis				
<b>KTM</b>						
Duke 390	17	21			KTM311	41,80
Duke 790	18	22			KTM300	43,50
Duke 890 R	20	22			KTM300	43,50
Duke 1290R	20	22			KTM300	43,50
<b>MV</b>						
Brutale - 4 cilindri tous / alle	01	17			KTM320	41,80
Brutale B3 - 3 cilindri 675 / 800	12	17			KTM320	41,80
F3 675 / 800	11	17			KTM319	41,80
F4 tous / alle	10	17			KTM323	41,80
<b>SUZUKI</b>						
Gladius 650	09	15			KTM309	41,80
GSR 600	06	11			KTM305	41,80
GSR 750	11	16			KTM305	41,80
GSXR 600 / 750	00	05			KTM305	41,80
GSXR 600 / 750	06	16			KTM309	41,80
GSXR 1000	03	04			KTM305	41,80
GSXR 1000	05	16			KTM309	41,80
GSXR 1000	17	22			KTM327	46,30
GSXS 750	17	21			KTM328	43,50
GSXS 1000	15	21			KTM300	43,50
<b>TRIUMPH</b>						
Street Triple 675	07	12			KTM300	43,50
Street Triple 675 R	13	16			KTM311	41,80
Street Triple 765 R / S / RS	17	22			KTM311	41,80
<b>YAMAHA</b>						
Fazer 600 - FZ6	04	06			KTM310	41,80
FZ1	06	11			KTM311	41,80
Fazer 1000	01	12			KTM310	41,80
MT-07 / XSR-700	14	20			KTM310	41,80
MT-09 / SP	13	20			KTM310	41,80
MT-09 / SP	21	22			KTM311	41,80
MT-10	16	21			KTM310	41,80
R 125	08	13			KTM310	41,80
R1 / R1M	98	22			KTM311	41,80
R3	15	22			KTM311	41,80
R6	06	22			KTM311	41,80
R7	22	22			KTM311	41,80
T Max 500 - 530 - 560	02	21			KTM310	41,80
X-Max 400	13	19			KTM310	41,80



# EMBOUS DE GUIDON

## 104 STRUKTURIERTE LENKERGEWICHTE



### NEW LOOK, BEST COMFORT

Réduction des vibrations du guidon par rapport aux embouts en alu

Die Vibrationen des Lenkers werden somit, im Vergleich zu den Lenkergewichten aus Aluminium, reduziert.

Description - Beschreibung	Année- Jahr		Mesure - Maß	Code - Code	€
	du - von	au - bis			
Universel / Universal			d.12/13/17	KTM200	<b>35,00</b>
<b>APRILIA</b>					
RS 660	20	22		KTM231	<b>37,80</b>
RSV4 (all versions)	09	22		KTM203	<b>37,80</b>
<b>BMW</b>					
R Nine-T / Scrambler / Pure / Urban / Racer	16	19		KTM225	<b>37,80</b>
S1000R	14	20		KTM225	<b>37,80</b>
S1000RR	09	18		KTM225	<b>37,80</b>
S1000RR	19	22		KTM230	<b>37,80</b>
<b>DUCATI</b>					
Diavel	11	18	d.12	KTM200	<b>40,10</b>
Monster 821	14	20	d.17	KTM200	<b>40,10</b>
Monster 1200 S / R	17	20		KTM200	<b>40,10</b>
Multistrada	03	09		KTM205	<b>37,80</b>
Panigale 899 / 1199 / 1299	12	17		KTM218	<b>37,80</b>
Panigale 959	16	20		KTM218	<b>37,80</b>
Panigale V2 955	20	22		KTM218	<b>37,80</b>
Panigale V4 / V4 S / V4 R / Speciale	18	22		KTM229	<b>37,80</b>
Streetfighter V2	21	22	d.13	KTM200	<b>40,10</b>
Streetfighter V4 / S	20	22	d.14,5	KTM222	<b>37,80</b>
848	08	11	d.12	KTM200	<b>40,10</b>
1098 / 1198	07	11	d.17	KTM200	<b>40,10</b>
<b>HONDA</b>					
tous / alle	..	..		KTM206	<b>37,80</b>
<b>KAWASAKI</b>					
ER-6N	12	16		KTM204	<b>37,80</b>
Ninja 250 / Ninja 300 / Ninja 400	18	21		KTM204	<b>37,80</b>
Z125	19	20		KTM204	<b>37,80</b>
Z400	17	21		KTM204	<b>37,80</b>
Z650	17	20		KTM226	<b>40,10</b>
Z750	04	12		KTM204	<b>37,80</b>
Z800	13	16		KTM207	<b>37,80</b>
Z900	17	22		KTM204	<b>37,80</b>
Z1000	03	16		KTM204	<b>37,80</b>
Z1000 SX	11	16		KTM204	<b>37,80</b>
ZX250R	09	12		KTM207	<b>37,80</b>
ZX6R / 636	03	20		KTM204	<b>37,80</b>
ZX10R	11	15		KTM204	<b>37,80</b>
ZX10R	16	22		KTM207	<b>37,80</b>





Description - Beschreibung	Année- Jahr		Mesure - Maß	Code - Code	€
	du - von	au - bis			
<b>KTM</b>					
Duke 390	17	21		KTM211	37,80
Duke 790	18	22		KTM200	40,10
Duke 890 R	20	22		KTM200	40,10
Duke 1290 R	20	22		KTM200	40,10
<b>MV</b>					
Brutale - 4 cilindri tous / alle	01	17		KTM220	37,80
Brutale B3 - 3 cilindri 675 / 800	12	17		KTM220	37,80
F3 675 / 800	11	17		KTM219	37,80
F4 tous / alle	10	17		KTM223	37,80
<b>SUZUKI</b>					
Gladius 650	09	15		KTM209	37,80
GSR 600	06	11		KTM205	37,80
GSR 750	11	16		KTM205	37,80
GSXR 600 / 750	00	05		KTM205	37,80
GSXR 600 / 750	06	17		KTM209	37,80
GSXR 1000	03	04		KTM205	37,80
GSXR 1000	05	16		KTM209	37,80
GSXR 1000	17	22		KTM227	43,50
GSXS 750	17	21		KTM228	40,10
GSXS 1000	15	21		KTM200	40,10
<b>TRIUMPH</b>					
Street Triple 675	07	12		KTM200	40,10
Street Triple 675 R	13	16		KTM211	37,80
Street Triple 765 R / S / RS	17	22		KTM211	37,80
<b>YAMAHA</b>					
Fazer 600 - FZ6	04	06		KTM210	37,80
FZ1	06	11		KTM211	37,80
Fazer 1000	01	12		KTM210	37,80
MT-07 / XSR-700	14	20		KTM210	37,80
MT-09 / SP	13	20		KTM210	37,80
MT-09 / SP	21	22		KTM211	37,80
MT-10	16	21		KTM210	37,80
R 125	08	13		KTM210	37,80
R1 / R1M	98	22		KTM211	37,80
R3	15	22		KTM211	37,80
R6	06	22		KTM211	37,80
R7	22	22		KTM211	37,80
T Max 500 - 530 - 560	02	21		KTM210	37,80
X-Max 400	13	19		KTM210	37,80



BORN  
TO BE  
MOTO





**RÉTROVISEURS  
SPIEGEL**



## RETROVISEURS ALUMINIUM POUR NAKED

108 SPIEGEL AUS ALUMINIUM FÜR NAKED BIKES

HOMOLOGATED



Homologué  
Homologiert



Paire rétro aluminium (filetage 2xM10x1,25 Right + 1xM10x1,25 Left)  
Aluminium Spiegel Paar (Gewinde das 2xM10x1,25 Right + 1xM10x1,25 Left)

■ SPEAL031NER

pour la paire/1 Paar  
€ 249,60

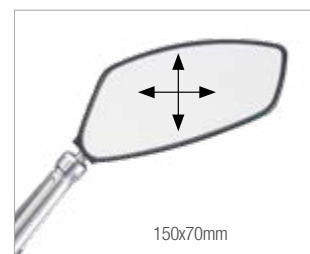

Paire rétro aluminium (filetage 2xM10x1,25 Right + 1xM10x1,25 Left)  
 Aluminium Spiegel Paar (Gewinde das 2xM10x1,25 Right + 1xM10x1,25 Left)

■ SPEAL027NER

pour la paire/1 Paar  
**€ 237,00**

# RETROVISEURS ALUMINIUM POUR NAKED

110 SPIEGEL AUS ALUMINIUM FÜR NAKED BIKES



<p>Paire rétro aluminium (filetage 2xM10x1,25 Right + 1xM10x1,25 Left) Aluminium Spiegel Paar (Gewinde das 2xM10x1,25 Right + 1xM10x1,25 Left)</p>	<p>□ SPEAL014BIA ■ SPEAL014NER ■ SPEAL014ROS</p>	<p><b>pour la paire/1 Paar</b> <b>€ 237,00</b></p>
<p>Paire de rétroviseurs pour T-MAX, fixation sur guidon Spiegelpaar für T-MAX, am Lenker befestigt</p>	<p>□ SPEAL015BIA ■ SPEAL015NER ■ SPEAL015ROS</p>	<p><b>€ 237,00</b></p>
<p>Paire de rétroviseurs pour T-MAX, fixation sur carénage, adaptateurs inclus Spiegelpaar für T-MAX, Befestigung an der Verkleidung, Adapter inklusive</p>	<p>□ SPEAL019BIA ■ SPEAL019NER ■ SPEAL019ROS</p>	<p><b>€ 317,10</b></p>



<p>Kit de conversion de support de rétroviseurs T Max SPEAL015 (du guidon au carénage) en combinaison avec SPEY09 Kit Anpassung Spiegeladapter T-Max SPEAL015 (von Lenker auf Verkleidung) in Kombination mit SPEY09</p>	<p>■ SPEY10</p>	<p><b>pour la paire/1 Paar</b> <b>€ 41,80</b></p>
<p>Kit de conversion de support de rétroviseur (SPEAL015) pour T-MAX (de carénage au guidon) avec leviers d'origine Änderungskit für Spiegelhalterung (SPEAL015) für T-Max ( aus Verkleidung zum Lenker) mit originalen Hebeln</p>	<p>■ SPEY12</p>	<p><b>€ 41,80</b></p>
<p>Kit de conversion de support de rétroviseur (SPEAL015) pour T-MAX (de carénage au guidon) avec leviers Lighttech Änderungskit für Spiegelhalterung (SPEAL015) für T-Max ( aus Verkleidung zum Lenker) mit Lighttech Hebeln</p>	<p>■ SPEY13</p>	<p><b>€ 41,80</b></p>
<p>Paire d'adaptateurs rétroviseurs avec filetage (de M10x1.25 femelle à M10 mâle DROITE + GAUCHE) Paar Spiegeladapter mit Gewinde (von M10x1,25 auf M10 / Right + Left)</p>	<p>■ SPEAL021NER</p>	<p><b>€ 13,70</b></p>
<p>Paire d'adaptateurs rétroviseurs avec filetage (de M10x1.25 femelle à M8 mâle DROITE + GAUCHE) Paar Spiegeladapter mit Gewinde (von M10x1,25 auf M8 / Right + Left)</p>	<p>■ SPEAL022</p>	<p><b>€ 13,70</b></p>
<p>Paire d'adaptateurs rétroviseurs pour BMW avec filet (de M10x1.5 a M8/ droit + gauche) Paar Spiegeladapter mit Gewinde (von M10x1,5 auf M8 / Right + Left) für BMW</p>	<p>■ SPEAL025</p>	<p><b>€ 13,70</b></p>
<p>Kit visserie pour montage des rétroviseurs SPEAL015 sur le T Max (avec leviers d'origine) Schraubenkit für Montage Spiegel SPEAL015 auf T-Max (mit originalen Hebel)</p>	<p>■ SPEAL026</p>	<p><b>€ 13,70</b></p>
<p>Paire d'adaptateurs rétroviseurs pour la conversion de M8 DROITE en M8 (DROITE + GAUCHE) Paar Spiegeladapter für Anpassung von M8 DX auf M8 (DX+SX)</p>	<p>■ SPEAL030</p>	<p><b>€ 13,70</b></p>
<p>Paire d'adaptateurs rétroviseurs pour MV AGUSTA BRUTALE 4 CYLINDRES Paar Spiegeladapter für MV Agusta Brutale 4 ZYLINDER</p>	<p>■ SPEAL032</p>	<p><b>€ 20,60</b></p>
<p>Kit visserie pour rétroviseurs SPEAL014 avec filetage M8 DROIRE + GAUCHE Schraubenkit für Spiegel SPEAL014 mit Gewinde M8 DX+SX</p>	<p>■ SPEAL033</p>	<p><b>€ 13,70</b></p>







**COUVRE RÉTROVISEUR**  
SPIEGEL ABDECKUNG

# COUVRE RÉTROVISEUR

112 SPIEGEL ABDECKUNG

Modèle - Modell		Année - Jahr		Code - Code	€	
pour la paire/1 Paar						
APRILIA	RS 660	20	22	■ ■	SPE111	37,80
	RSV4 (all versions)	09	22	■ ■	SPE111	37,80
BMW	S1000 RR	09	18	■ ■ ■ ■	SPE101	33,20
	S1000 RR	19	22	■ ■ ■ ■	SPE122	55,00
DUCATI	Panigale 899 / 1199	12	15	■ ■	SPE113	65,30
	Panigale 1299	15	17	■ ■	SPE117	55,00
	Panigale 959	16	21	■ ■	SPE117	55,00
	Panigale V4 / S	18	19	■ ■	SPE121	55,00
	Panigale V4 / S	20	21	■ ■	SPE123	55,00
	Panigale V4 R	20	21	■ ■	SPE123	55,00



SPE111

SPE101

SPE122

SPE117





















SPE121

SPE123



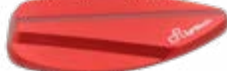

 FINE DE LA SÉRIE - AUSLAUFARTIKEL

Modèle - Modell	Année - Jahr		Code - Code	€			
pour la paire/1 Paar							
<b>HONDA</b>	CBR 500R	16	20		SPE102	33,20	 SPE105  SPE125
	CBR 600 RR	04	16		SPE105	33,20	
	CBR 1000 RR	04	07		SPE105	33,20	
	CBR 1000 RR / CBR 1000 RR-R / SP	08	22		SPE125	55,00	
<b>KAWASAKI</b>	Ninja 400	18	21		SPE118	37,80	 SPE102  SPE110  SPE112 SPE118  SPE127
	ZX6R	05	08		SPE102	33,20	
	ZX6R	09	12		SPE110	33,20	
	ZX10R	04	07		SPE102	33,20	
	ZX10R	11	15		SPE112	37,80	
	ZX10R	16	21		<b>SPE118</b>	37,80	
	ZX10R	16	22		SPE127	55,00	
<b>MV AGUSTA</b>	F3 675 / F3 800	12	20		SPE114	49,20	 SPE114



# COUVRE RÉTROVISEUR

114 SPIEGEL ABDECKUNG

Modèle - Modell		Année - Jahr		Code - Code	€		
pour la paire/1 Paar							
SUZUKI	GSXR 600 / 750 / 1000	05	16		SPE103	33,20	 
	GSXR 1000	17	22		SPE119	55,00	
YAMAHA	R3	19	22		SPE126	55,00	      
	R6	99	07		SPE104	33,20	
	R6	17	22		SPE120	55,00	
	R7	22	22		SPE120	55,00	
	R1	98	06		SPE104	33,20	
	R1	07	1a		SPE101	33,20	
	R1 / R1M	15	19		SPE115	55,00	
	R1 / R1M	20	22		SPE124	55,00	
	T Max 530 - 560	12	22		SPEY08	56,10	





**SUPPORT DE PLAQUE**  
KENNZEICHENHALTER

# SUPPORT DE PLAQUE REGLABLE

116 VERSTELLBARE KENNZEICHENHALTER

## FACILE ET RAPIDE

EINFACH UND SCHNELL

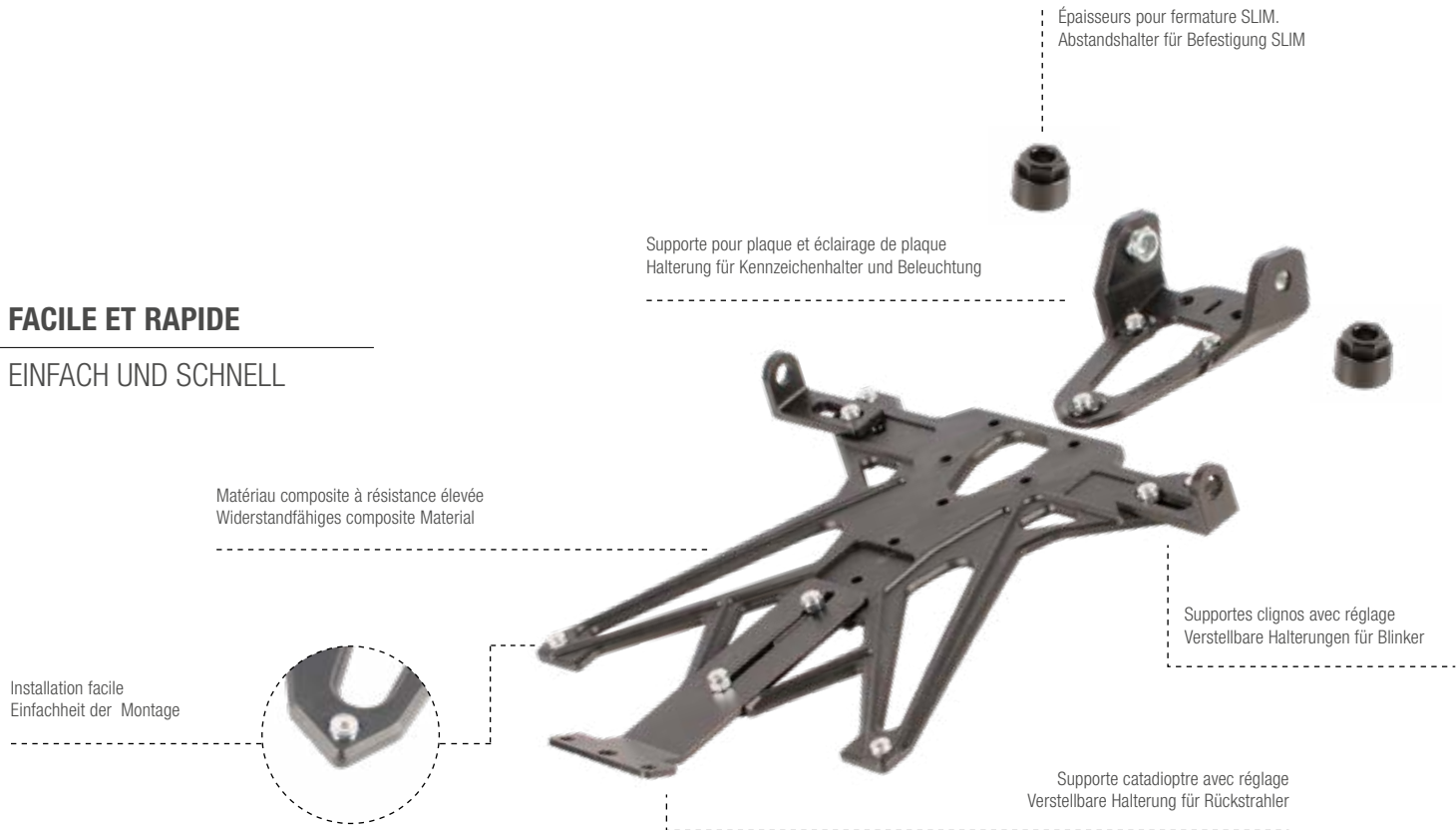

## DANS LE PLEIN RESPECT DU CODE DE LA ROUTE

IN ÜBEREINSTIMMUNG MIT DER STRASSENVERKEHRSORDNUNG

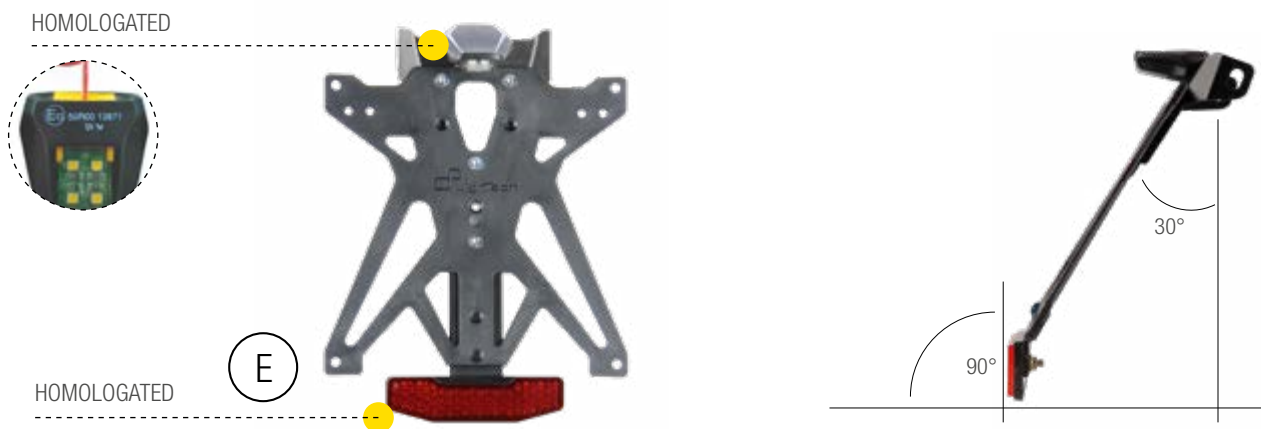





**KIT SUPPORTE DE PLAQUE COMPLET AVEC CATADIOPTRE ET FEU APPROUVÉS**  
KIT KENNZEICHENHALTER KOMPLETT MIT HOMOLOGIERTEN RÜCKSTRAHLER UND BELEUCHTUNG



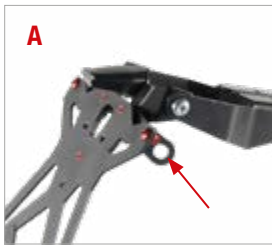

**A**  
Trou pour clignotant racing  
Bohrung für Blinker für Rennmaschine

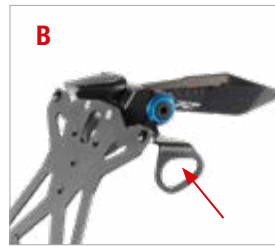

**B**  
Trou pour clignotant originale  
Bohrung für originale Blinker



**C**  
Feux fournis  
Beleuchtung serienmäßig dabei



**D**  
Avec catadioptre  
Mit Rückstrahler

**\*\***

**IMPORTANT** : ajouter le code d'état à la référence (voir exemple page 126)

**WICHTIG** : ergänzen Sie den Code mit den Buchstaben des Staates (siehe Beispiel auf Seite 126)

Modél - Modell	Année- Jahr		Trou pour clignotants Loch für Blinker		Feux Beleuchtung	Catadioptre Rückstrahler	TÜV homologated	Code - Code	€	
	du - von	au - bis	racing	original						
Universal voir page 125 / siehe Seite 125			✓				KBA 91919	TAR013	61,80	
<b>APRILIA</b>										
RS 660	20	22	✓	✓	LT009	✓	YES	KTARAP109**	108,80	kit
			✓	✓				TARAP109**	80,10	
Dorsoduro 900	17	20	✓	✓	LT009	✓	YES	KTARAP108**	108,80	kit
			✓	✓				TARAP108**	80,10	
Dorsoduro 1200	11	15	✓	✓	LT009	✓	NO	KTARAP108**	108,80	kit
			✓	✓				TARAP108**	80,10	
RSV4 (all versions)	09	20	✓	✓	LT009	✓	YES	KTARAP107**	105,30	kit
			✓	✓				TARAP107**	76,10	
RSV4 1100 Factory	21	22	✓	✓	LT009	✓	YES	KTARAP109**	108,80	kit
			✓	✓				TARAP109**	80,10	
Tuono 660	20	22	✓	✓	LT009	✓	NO	KTARAP109**	108,80	kit
			✓	✓				TARAP109**	80,10	
Tuono V4 (all versions)	11	20	✓	✓	LT009	✓	YES	KTARAP107**	105,30	kit
			✓	✓				TARAP107**	76,10	
Tuono 1100 Factory	21	22	✓	✓	LT009	✓	YES	KTARAP109**	108,80	kit
			✓	✓				TARAP109**	80,10	
<b>BENELLI</b>										
BN 125	18	21	✓	✓	LT009	✓	NO	KTARBN101**	108,80	kit
			✓	✓				TARBN101**	80,10	
BN 302	19	21	✓	✓	LT009	✓	NO	KTARBN102**	108,80	kit
			✓	✓				TARBN102**	80,10	
<b>BMW</b>										
C600 Sport	12	15	✓	✓	LT009	✓	NO	KTARBM104**	141,90	kit
			✓	✓				TARBM104**	112,20	
R 1200 GS	13	17		✓	LT009	✓	NO	KTARBM108**	105,30	kit
				✓				TARBM108**	76,10	
R Nine-T / Scrambler / Pure / Urban / Racer	16	19	✓	✓	LT009	✓	NO	KTARBM109**	366,30	kit
R Nine-T / Scrambler / Pure / Urban / Racer	16	19	✓	✓	LT009	✓	NO	KTARBM110**	366,30	kit
voir page 125 / siehe Seite 125										
S1000R	14	20	✓	✓	LT009	✓	YES	KTARBM105**	122,50	kit
			✓	✓				TARBM105**	93,90	
S1000R	21	22		✓	LT009	✓	—	KTARBM111**	122,50	kit
				✓				TARBM111**	93,90	

NEW!

Modél - Modell	Année- Jahr		A Trou pour clignotants Loch für Blinker		B	C Feux Beleuchtung	D Catadioptre Rückstrahler	TÜV homologated	Code - Code	€	FINE DE LA SÉRIE - AUSLAUFARTIKEL
	du - von	au - bis	racing	original						KBA 91919	
<b>BMW</b>											
S1000RR / HP4	09	18	✓	✓	LT009	✓	YES	KTARBM105**	122,50	kit	
			✓	✓				TARBM105**	93,90		
S1000RR	19	22		✓	LT009	✓	YES	KTARBM111**	122,50	kit	
				✓				TARBM111**	93,90		
M1000 RR	21	22		✓	LT009	✓	—	KTARBM111**	122,50	kit	
				✓				TARBM111**	93,90		
<b>CF MOTO</b>											
650 NK	21	22	✓	✓	LT009	✓	NO	KTARCF101**	108,80	kit	
			✓	✓				TARCF101**	80,10		
<b>DUCATI</b>											
848 - 1098 - 1198	07	11	✓	✓	LT009	✓	NO	KTARDU104**	108,80	kit	
			✓	✓				TARDU104**	80,10		
Hypermotard 796 - 1100	07	12	✓		LT009	✓	NO	KTARDU105**	105,30	kit	
			✓					TARDU105**	76,10		
Hypermotard 821 / 939	13	18	✓		LT009	✓	YES	KTARDU110**	114,50	kit	
			✓					TARDU110**	84,70		
Hypermotard 950 / SP	19	22	✓	✓	LT009	✓	YES	KTARDU114**	114,50	kit	
			✓	✓				TARDU114**	84,70		
Monster 797	17	20	✓	✓	LT009	✓	YES	KTARDU112**	114,50	kit	
			✓	✓				TARDU112**	84,70		
Monster 937	21	22	✓	✓	LT009	✓	YES	KTARDU115**	114,50	kit	
			✓	✓				TARDU115**	84,70		
Monster 1200 / S / R	17	21	✓	✓	LT009	✓	YES	KTARDU112**	114,50	kit	
			✓	✓				TARDU112**	84,70		
Multistrada V4 / S	21	22	✓	✓	LT009	✓	NO	KTARDU116**	189,00	kit	
			✓	✓				TARDU116**	158,80		
Panigale 899	12	17	✓	✓	LT009	✓	YES	KTARDU109**	237,00	kit	
			✓	✓				TARDU109**	208,40		
Panigale 959	16	20	✓	✓	LT009	✓	YES	KTARDU109**	237,00	kit	
			✓	✓				TARDU109**	208,40		
Panigale 1199 / 1299 R / S / Superleggera	12	17	✓	✓	LT009	✓	YES	KTARDU109**	237,00	kit	
			✓	✓				TARDU109**	208,40		
Panigale V2 955	20	22	✓	✓	LT009	✓	YES	KTARDU113**	237,00	kit	
			✓	✓				TARDU113**	208,40		
Panigale V4 / S / R / Speciale	18	22	✓	✓	LT009	✓	YES	KTARDU113**	237,00	kit	
			✓	✓				TARDU113**	208,40		
Supersport 939 / S	17	20	✓	✓	LT009	✓	YES	KTARDU112**	114,50	kit	
			✓	✓				TARDU112	84,70		
Supersport 950 / S	21	22	✓	✓	LT009	✓	YES	KTARDU112**	114,50	kit	
			✓	✓				TARDU112	84,70		
Streetfighter V2 / S	21	22	✓	✓	LT009	✓	YES	KTARDU113**	237,00	kit	
			✓	✓				TARDU113**	208,40		
Streetfighter V4 / S	20	22	✓	✓	LT009	✓	YES	KTARDU113**	237,00	kit	
			✓	✓				TARDU113**	208,40		

NEW!

NEW!



Modél - Modell	Année- Jahr	Trou pour clignotants Loch für Blinker		Feux Beleuchtung	Catadioptre Rückstrahler	TÜV homologated	Code - Code	€	KBA 91919	
		du - von	au - bis							racing
<b>FANTIC</b>										
Caballero 125 / 250 / 500 Scrambler / Rally	19	22	✓	✓	LT009	✓	YES	KTARFA101**	105,30	kit
			✓	✓				TARFA101**	76,10	
Caballero 125 / 250 / 500 - flat track	19	22	✓	✓	LT009	✓	NO	KTARFA102**	105,30	kit
			✓	✓				TARFA102**	76,10	
<b>GUZZI</b>										
Griso 850 / 1100 / 1150	06	16	✓	✓	LT009	✓	NO	KTARGU101**	105,30	kit
			✓	✓				TARGU101**	76,10	
<b>HONDA</b>										
CB 125R / CB300R	18	22	✓	✓	LT009	✓	YES	KTARHO117**	105,30	kit
			✓	✓				TARHO117**	76,10	
CB 650 F	14	19	✓		LT009	✓	YES	KTARHO111**	105,30	kit
			✓					TARHO111**	76,10	
CB 650 R	19	20	✓	✓	LT009	✓	YES	KTARHO118**	105,30	kit
			✓	✓				TARHO118**	76,10	
CB 650 R	21	22	✓	✓	LT009	✓	YES	KTARHO121**	114,50	kit
			✓	✓				TARHO121**	84,70	
CB 1000R	08	17	✓		LT009	✓	NO	KTARHO107**	105,30	kit
			✓					TARHO107**	76,10	
CB 1000R	18	20	✓	✓	LT009	✓	YES	KTARHO116**	114,50	kit
			✓	✓				TARHO116**	84,70	
CBR 500R	17	22	✓	✓	LT009	✓	YES	KTARHO120**	114,50	kit
			✓	✓				TARHO120**	84,70	
CBR 600 F	11	13	✓		LT009	✓	NO	KTARHO108**	105,30	kit
			✓					TARHO108**	76,10	
CBR 650 F	14	18	✓		LT009	✓	YES	KTARHO111**	105,30	kit
			✓					TARHO111**	76,10	
CBR 650 R	19	20	✓	✓	LT009	✓	YES	KTARHO118**	105,30	kit
			✓	✓				TARHO118**	76,10	
CBR 650 R	21	22	✓	✓	LT009	✓	YES	KTARHO121**	114,50	kit
			✓	✓				TARHO121**	84,70	
CBR 1000 RR	10	16	✓		LT009	✓	NO	KTARHO109**	105,30	kit
			✓					TARHO109**	76,10	
CBR 1000 RR	17	19	✓	✓	LT009	✓	YES	KTARHO114**	105,30	kit
			✓	✓				TARHO114**	76,10	
CBR 1000 RR-R / SP	20	22	✓	✓	LT009	✓	YES	KTARHO119**	122,50	kit
			✓	✓				TARHO119**	92,70	
Hornet 600	11	13	✓		LT009	✓	NO	KTARHO108**	105,30	kit
			✓					TARHO108**	76,10	
Integra 700 / 750	12	15	✓		LT008	✓	NO	KTARHO110**	104,70	kit
			✓		LT008			TARHO110**	100,70	
Integra 750	16	18	✓	✓	LT009	✓	NO	KTARHO113**	105,30	kit
			✓	✓				TARHO113**	76,10	
NC 700 / 700 X	12	15	✓		LT008	✓	NO	KTARHO110**	104,70	kit
			✓		LT008			TARHO110**	100,70	



Modél - Modell	Année- Jahr	Trou pour clignotants Loch für Blinker		Feux Beleuchtung	Catadioptre Rückstrahler	TÜV homologated	Code - Code	€		
		A	B							C
	du - von	au - bis	racing	original						
<b>HONDA</b>										
X-ADV 750	17	20		✓	LT009	✓	YES	KTARHO115**	207,20	kit
				✓				TARHO115**	178,60	
X-ADV 750	21	22		✓	LT009	✓	YES	KTARHO122**	185,50	kit
				✓				TARHO122**	156,80	
<b>HUSQVARNA</b>										
Nuda 900	11	13	✓	✓	LT009	✓	NO	KTARHU101**	129,40	kit
			✓	✓				TARHU101**	99,60	
Vitpilen 701	18	19	✓	✓	LT009	✓	NO	KTARHU102**	145,40	kit
			✓	✓				TARHU102**	116,20	
<b>KAWASAKI</b>										
ER - 6N	12	20	✓	✓	LT009	✓	NO	KTARKA116**	129,40	kit
			✓	✓				TARKA116**	99,60	
Ninja 125	19	22	✓	✓	LT009	✓	YES	KTARKA125**	105,30	kit
			✓	✓				TARKA125**	76,10	
Ninja 250	18	20	✓	✓	LT009	✓	NO	KTARKA124**	105,30	kit
			✓	✓				TARKA124**	76,10	
Ninja 300	12	16	✓		LT009	✓	NO	KTARKA118**	105,30	kit
			✓					TARKA118**	76,10	
Ninja 400	17	21	✓	✓	LT009	✓	YES	KTARKA124**	105,30	kit
			✓	✓				TARKA124**	76,10	
Ninja 650	16	22	✓	✓	LT009	✓	YES	KTARKA122**	108,80	kit
			✓	✓				TARKA122**	80,10	
Ninja 1000 SX	21	22	✓	✓	LT009	✓	YES	KTARKA115**	105,30	kit
			✓	✓				TARKA115**	76,10	
Versis 650	22	22	✓	✓	LT009	✓	—	KTARKA115**	105,30	kit
			✓	✓				TARKA115**	76,10	
Versis 1000	19	22	✓	✓	LT009	✓	YES	KTARKA115**	105,30	kit
			✓	✓				TARKA115**	76,10	
Z 125	19	22	✓	✓	LT009	✓	YES	KTARKA125**	105,30	kit
			✓	✓				TARKA125**	76,10	
Z 300	12	16	✓		LT009	✓	NO	KTARKA118**	105,30	kit
			✓					TARKA118**	76,10	
Z 400	17	21	✓	✓	LT009	✓	YES	KTARKA124**	105,30	kit
			✓	✓				TARKA124**	76,10	
Z 650	16	22	✓	✓	LT009	✓	YES	KTARKA122**	108,80	kit
			✓	✓				TARKA122**	80,10	
Z 750	07	14	✓		LT009	✓	NO	KTARKA109**	105,30	kit
			✓					TARKA109**	76,10	
Z 800	13	16	✓		LT009	✓	NO	KTARKA117**	105,30	kit
			✓					TARKA117**	76,10	
Z 900	17	22	✓	✓	LT009	✓	YES	KTARKA123**	108,80	kit
			✓	✓				TARKA123**	80,10	
Z 1000	07	09	✓		LT009	✓	NO	KTARKA109**	105,30	kit
			✓					TARKA109**	76,10	

NEW!

FINE DE LA SÉRIE - AUSLAUFARTIKEL

Modél - Modell	Année- Jahr	Trou pour clignotants Loch für Blinker		Feux Beleuchtung	Catadioptre Rückstrahler	TÜV homologated	Code - Code	€	KBA 91919	
		du - von	au - bis							racing
<b>KAWASAKI</b>										
Z 1000	10	13	✓	✓	LT009	✓	YES	KTARKA115**	105,30	kit
			✓	✓				TARKA115**	76,10	
Z 1000	14	20	✓		LT009	✓	YES	KTARKA119**	105,30	kit
			✓					TARKA119**	76,10	
Z 1000 SX	11	20	✓	✓	LT009	✓	YES	KTARKA115**	105,30	kit
			✓	✓				TARKA115**	76,10	
Z H2	20	22	✓	✓	LT009	✓	YES	KTARKA123**	108,80	kit
			✓	✓				TARKA123**	80,10	
ZX6R / ZX636	13	17	✓		LT009	✓	YES	KTARKA120**	105,30	kit
			✓					TARKA120**	76,10	
ZX6R / 636	19	21	✓	✓	LT009	✓	YES	KTARKA126**	105,30	kit
			✓	✓				TARKA126**	76,10	
ZX10 R	08	10	✓		LT009	✓	NO	KTARKA120**	105,30	kit
			✓					TARKA120**	76,10	
ZX10 R	16	20	✓		LT009	✓	YES	KTARKA121**	105,30	kit
			✓					TARKA121**	76,10	
ZX10 R	21	22	✓	✓	LT009	✓	—	KTARKA127**	105,30	kit
			✓	✓				TARKA127**	76,10	
<b>KEEWAY</b>										
RKF 125	18	22	✓		LT009	✓	YES	KTARKE101**	105,30	kit
			✓					TARKE101**	76,10	
<b>KTM</b>										
Duke 125 / 390	17	21	✓	✓	LT009	✓	YES	KTARKT105**	129,40	kit
			✓	✓				TARKT105**	99,60	
Duke 690	12	16	✓		LT003	✓	NO	KTARKT103**	96,20	kit
			✓		LT003			TARKT103**	91,60	
Duke 790	18	22	✓	✓	LT007	✓	YES	KTARKT106**	129,40	kit
			✓	✓	LT007			TARKT106**	125,40	
Duke 890 R	20	22	✓	✓	LT007	✓	YES	KTARKT106**	129,40	kit
			✓	✓	LT007			TARKT106**	125,40	
RC 125 / 200 / 390	17	21	✓	✓	LT009	✓	NO	KTARKT107**	129,40	kit
			✓	✓				TARKT107**	99,60	
Super Duke 1290 - R	20	22	✓	✓	LT009	✓	YES	KTARKT109**	237,00	kit
			✓	✓				TARKT109**	208,40	
<b>MV AGUSTA</b>										
Brutale 750 / 910 / 990 / 1090	01	14	✓		LT009	✓	NO	KTARMV101**	105,30	kit
			✓					TARMV101**	76,10	
Brutale 675 / 800	12	16	✓		LT009	✓	NO	KTARMV105**	105,30	kit
			✓					TARMV105**	76,10	
F3 675 / F3 800	12	18	✓		LT009	✓	NO	KTARMV104**	105,30	kit
			✓					TARMV104**	76,10	
F4	10	12	✓	✓	LT009	✓	NO	KTARMV103**	108,80	kit
			✓	✓				TARMV103**	80,10	
F4	13	16	✓		LT009	✓	NO	KTARMV106**	108,80	kit
			✓					TARMV106**	80,10	



Modél - Modell	Année- Jahr	A		B		C		D		FINE DE LA SÉRIE - AUSLAUFARTIKEL	Code - Code	€
		Trou pour clignotants Loch für Blinker		Feux Beleuchtung		Catadioptre Rückstrahler		TÜV homologated				
	du - von	au - bis	racing	original								
<b>SUZUKI</b>												
GSR 750	11	16	✓		LT009	✓	NO	KTARSU110**	105,30	kit		
			✓					TARSU110**	76,10			
GSX-R 125 / GSX-S 125	17	20	✓		LT009	✓	YES	KTARSU115**	105,30	kit		
			✓					TARSU115**	76,10			
GSX 250 R	17	20	✓		LT009	✓	YES	KTARSU114**	105,30	kit		
			✓					TARSU114**	76,10			
GSXR 600 / 750	11	17	—	—	LT009	✓	NO	KTARSU109**	105,30	kit		
			—	—				TARSU109**	76,10			
GSXR 1000	05	08	—	—	LT009	✓	NO	KTARSU101**	105,30	kit		
			—	—				TARSU101**	76,10			
GSXR 1000	09	16	—	—	LT009	✓	YES	KTARSU102**	105,30	kit		
			—	—				TARSU102**	76,10			
GSXR 1000 / R	17	22		✓	LT009	✓	YES	KTARSU113**	114,50	kit		
				✓				TARSU113**	84,70			
GSX S 750	17	21	✓		LT009	✓	YES	KTARSU111**	105,30	kit		
			✓					TARSU111**	76,10			
NEW! GSX S 950	21	22	✓	✓	LT009	✓	YES	KTARSU117**	105,30	kit		
			✓	✓				TARSU117**	76,10			
GSX S 1000	15	20	✓		LT009	✓	YES	KTARSU111**	105,30	kit		
			✓					TARSU111**	76,10			
NEW! GSX S 1000	21	22	✓	✓	LT009	✓	YES	KTARSU117**	105,30	kit		
			✓	✓				TARSU117**	76,10			
SV 650	16	20	✓		LT009	✓	YES	KTARSU112**	105,30	kit		
			✓					TARSU112**	76,10			
<b>TRIUMPH</b>												
Daytona 675 / 675R	12	16	✓	✓	LT009	✓	YES	KTARTR106**	108,80	kit		
			✓	✓				TARTR106**	80,10			
Street Triple 675 / 675R	07	12	✓		LT009	✓	NO	KTARTR103**	108,80	kit		
			✓					TARTR103**	80,10			
Street Triple 675 / 675R	13	16	✓	✓	LT009	✓	YES	KTARTR106**	108,80	kit		
			✓	✓				TARTR106**	80,10			
Street Triple 765S / 765R / 765RS	17	22	✓	✓	LT009	✓	YES	KTARTR106**	108,80	kit		
			✓	✓				TARTR106**	80,10			
Speed Triple 1050 / 1050R	11	15	✓		LT009	✓	NO	KTARTR105**	105,30	kit		
			✓					TARTR105**	76,10			
Speed Triple 1050 / S	16	20	✓	✓	LT009	✓	YES	KTARTR107**	108,80	kit		
attention non installabile con frecce originali su modello RS			✓	✓				TARTR107**	80,10			
NEW! Speed Triple RS 1200	21	22	✓	✓	LT009	✓	YES	KTARTR108**	114,50	kit		
			✓	✓				TARTR108**	84,70			
NEW! Trident 660	21	22	✓	✓	LT009	✓	NO	KTARTR109**	192,60	kit		
			✓	✓				TARTR109**	163,90			
<b>YAMAHA</b>												
Fazer 600 / FZ6	04	12	✓	✓	LT009	✓	NO	KTARYA106**	105,30	kit		
			✓	✓				TARYA106**	76,10			
FZ8	10	15	✓	✓	LT009	✓	NO	KTARYA109**	105,30	kit		
			✓	✓				TARYA109**	76,10			

Modél - Modell	Année- Jahr		A	B	C	D	TÜV homologated	Code - Code	€	
	du - von	au - bis	Trou pour clignotants Loch für Blinker		Feux Beleuchtung	Catadioptre Rückstrahler				
			racing	original						KBA 91919
<b>YAMAHA</b>										
Fazer 1000 / FZ1	06	15	✓	✓	LT009	✓	NO	KTARYA109**	105,30	kit
			✓	✓				TARYA109**	76,10	
MT-03	15	20	✓		LT009	✓	YES	KTARYA120**	105,30	kit
			✓					TARYA120**	76,10	
MT-07	13	22	✓	✓	LT009	✓	YES	KTARYA125**	111,00	kit
			✓	✓				TARYA125**	81,90	
MT-09	13	16	✓	✓	LT009	✓	YES	KTARYA116**	105,30	kit
			✓	✓				TARYA116**	76,10	
MT-09 / SP	21	22	✓	✓	LT009	✓	YES	KTARYA128**	108,80	kit
			✓	✓				TARYA128**	80,10	
MT-09 Tracer / Tracer GT	15	20	✓	✓	LT009	✓	YES	KTARYA119**	112,20	kit
			✓	✓				TARYA119**	83,60	
MT-09 Tracer / Tracer GT	21	22	✓	✓	LT009	✓	—	KTARYA130**	112,20	kit
			✓	✓				TARYA130**	83,60	
MT-10 / SP	16	21	✓	✓	LT009	✓	YES	KTARYA121**	112,20	kit
			✓	✓				TARYA121**	83,60	
R 125	19	22	✓	✓	LT009	✓	YES	KTARYA126**	105,30	kit
			✓	✓				TARYA126**	76,10	
R1	04	08	✓	✓	LT009	✓	YES	KTARYA103**	105,30	kit
			✓	✓				TARYA103**	76,10	
R1	09	14	✓	✓	LT009	✓	NO	KTARYA104**	105,30	kit
			✓	✓				TARYA104**	76,10	
R1 - R1M	15	22	✓	✓	LT009	✓	YES	KTARYA118**	206,60	kit
			✓	✓				TARYA118**	177,40	
R3	15	22	✓		LT009	✓	YES	KTARYA120**	105,30	kit
			✓					TARYA120**	76,10	
R6	06	16	✓	✓	LT009	✓	YES	KTARYA103**	105,30	kit
			✓	✓				TARYA103**	76,10	
R6	17	22	✓	✓	LT009	✓	YES	KTARYA122**	105,30	kit
			✓	✓				TARYA122**	76,10	
R7	22	22	✓	✓	LT009	✓	—	KTARYA131**	105,30	kit
			✓	✓				TARYA131**	76,10	
Tenere 700	19	22	✓		LT009	✓	—	KTARYA127**	114,50	kit
			✓					TARYA127**	84,70	
XJ6	08	15	✓	✓	LT009	✓	NO	KTARYA108**	105,30	kit
			✓	✓				TARYA108**	76,10	
T-Max 500 (con sottocodone / with undertail)	08	11	—	—	LT009	✓	YES	KTARYA112**	133,90	kit
			—	—				TARYA112**	104,80	
T-Max 500 (senza sottocodone / without undertail)	08	11	—	—	LT009	✓	NO	KTARYA113**	105,30	kit
			—	—				TARYA113**	76,10	
T-Max 530	12	16	—	—	LT009	✓	YES	KTARYA114**	105,30	kit
			—	—				TARYA114**	76,10	
T-Max 530 / 560	17	21	✓	✓	LT009	✓	YES	KTARYA124**	105,30	kit
			✓	✓				TARYA124**	76,10	

NEW!

NEW!

NEW!

FINE DE LA SÉRIE - AUSLAUFARTIKEL



KTARBM109 = (1) KIT Support de plaque réglable + (2) Support de phare **noir**  
 KTARBM110 = (1) KIT Support de plaque réglable + (2) Support de phare **argent**  
 KTARBM109 = (1) Verstellbare Kennzeichenhalter KIT + (2) **Schwarz** Halterung für Beleuchtung  
 KTARBM110 = (1) Verstellbare Kennzeichenhalter KIT + (2) **Silber** Halterung für Beleuchtung

**SUPPORT DE PLAQUE GÉNÉRIQUE ET ADAPTABLE**  
 UNIVERSELLER KENNZEICHENHALTER



Support de plaque générique et adaptable avec kit de application  
 Universeller Kennzeichenhalter mit Adapterkit

Couleur - Farben ■

TAR013\*\*

€ 61,80

# SUPPORT DE PLAQUE REGLABLE

**!** COMMENT COMPOSER LA CODE CORRECT / WIE KANN MAN DEN CODE ZUSAMMENSTELLEN  
(exemple pour **BMW 1000RR** avec support A2 / Beispiel **BMW S1000RR** mit Halterung A2)

Numéro de pièce du Kit de support de plaque / Teilenummer des Kennzeichenhalter-Kits + A2 = **KTARBM105A2**

**A1**

-  IT = Italia
-  DE = Deutschland
-  SLO = Slovenija

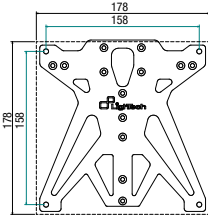

**MATERIAL**  
Composit Nylon PA12 + Carbon Fiber

Pièces de rechange pour supports de plaque réglables  
Ersatzteile für verstellbare Kennzeichenhalter

TAR014NER € 25,20

**A2**

-  F = France
-  CH = Schweiz

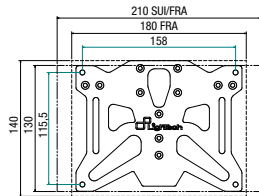

**MATERIAL**  
Composit Nylon PA12 + Carbon Fiber

Pièces de rechange pour supports de plaque réglables  
Ersatzteile für verstellbare Kennzeichenhalter

TAR015NER € 25,20

**A3**

-  E = España

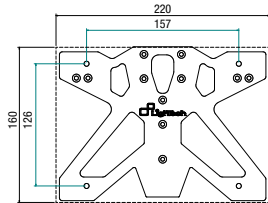

**MATERIAL**  
Composit Nylon PA12 + Carbon Fiber

Pièces de rechange pour supports de plaque réglables  
Ersatzteile für verstellbare Kennzeichenhalter

TAR017NER € 25,20

**B1**

-  CA = Canada
-  USA = United S.
-  P = Portugal

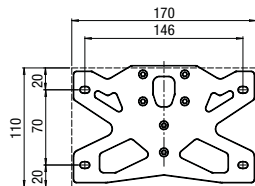

**MATERIAL**  
Aluminium

Pièces de rechange pour supports de plaque réglables  
Ersatzteile für verstellbare Kennzeichenhalter

TAR026NER € 29,80

**B2**

-  KOR = Korea

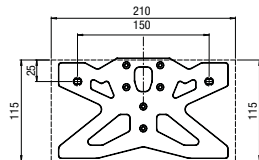

**MATERIAL**  
Aluminium

Pièces de rechange pour supports de plaque réglables  
Ersatzteile für verstellbare Kennzeichenhalter

TAR030NER € 29,80

**B3**

-  JAP = Japan

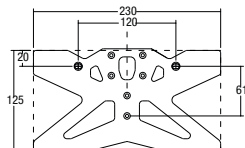

**MATERIAL**  
Aluminium

Pièces de rechange pour supports de plaque réglables  
Ersatzteile für verstellbare Kennzeichenhalter

TAR032NER € 29,80





Kit de supports de clignotants à LED de rechange  
Aftermarket Blinker Support Kit

TAR019 € 6,90



Support triangulaire pour le réglage de l'inclinaison  
Dreieckige Halterung zum Einstellen der Neigung

TAR021 € 10,30



Kit de bagues latérales  
Seitenbuchsen-Kit

TAR022 € 6,90

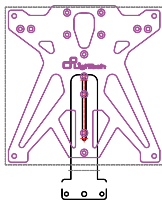

HOMOLOGATED	E13	KAT04	€ 13,70
-------------	-----	-------	---------

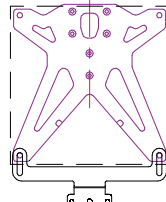

157 mm



HOMOLOGATED	E13	KAT01	€ 13,70
-------------	-----	-------	---------



HOMOLOGATED	E13	TAR024	€ 7,50
-------------	-----	--------	--------

Compatible avec tous les supports de plaque LightTech version 2019.  
Passend zu allen LightTech Kennzeichenhalter, Version 2019

## COMMENT PERSONNALISER LE SUPPORT DE PLAQUE LIGHTECH

128 WIE KANN MANN DEN LIGHTECH KENNZEICHENHALTER PERSONALISIEREN?

APPLICATIONS SPÉCIFIQUES POUR LES SUPPORTS DE PLAQUE  
SPEZIFISCHE ANWENDUNGEN FÜR KENNZEICHENHALTER

Code - Code		Code - Code		Code - Code	
<b>APRILIA</b>		<b>HUSQVARNA</b>		<b>TRIUMPH</b>	
KTARAP107	TAR025	KTARHU101	TAR009	KTARTR103	TAR009
KTARAP108	TAR025	KTARHU102	TAR025	KTARTR105	TAR009
KTARAP109	TAR025	<b>KAWASAKI</b>		KTARTR106	TAR025
<b>BMW</b>		KTARKA109	TAR009	KTARTR107	TAR009
KTARBM104	TAR009	KTARKA113	TAR008	KTARTR108	TAR025
KTARBM105	TAR009	KTARKA115	TAR009	KTARTR109	TAR009
KTARBM111	TAR025	KTARKA116	TAR009	<b>YAMAHA</b>	
<b>BENELLI</b>		KTARKA117	TAR009	KTARYA103	TAR009
KTARBN101	TAR025	KTARKA118	TAR009	KTARYA104	TAR009
<b>CF MOTO</b>		KTARKA119	TAR009	KTARYA108	TAR009
KTARCF101	TAR025	KTARKA120	TAR009	KTARYA109	TAR009
<b>DUCATI</b>		KTARKA121	TAR009	KTARYA112	TAR009
KTARDU104	TAR009	KTARKA122	TAR025	KTARYA113	TAR009
KTARDU105	TAR009	KTARKA123	TAR025	KTARYA114	TAR009
KTARDU106	TAR009	KTARKA124	TAR025	KTARYA116	TAR025
KTARDU109	TAR008	KTARKA125	TAR025	KTARYA118	TAR008
KTARDU110	TAR009	KTARKA126	TAR025	KTARYA119	TAR025
KTARDU112	TAR029	KTARKA127	TAR025	KTARYA120	TAR009
KTARDU113	TAR008	<b>KEEWAY</b>		KTARYA121	TAR009
KTARDU114	TAR025	KTARKE101	TAR025	KTARYA122	TAR025
KTARDU115	TAR025	<b>KTM</b>		KTARYA124	TAR009
KTARDU116	TAR009	KTARKT103	TAR009	KTARYA125	TAR025
<b>FANTIC</b>		KTARKT105	TAR025	KTARYA126	TAR025
KTARFA101	TAR025	KTARKT106	TAR025	KTARYA127	TAR025
KTARFA102	TAR009	KTARKT107	TAR025	KTARYA128	TAR025
<b>GUZZI</b>		KTARKT109	TAR008	KTARYA130	TAR025
KTARGU101	TAR009	<b>MV AUGUSTA</b>		KTARYA131	TAR009
<b>HONDA</b>		KTARMV101	TAR009		
KTARHO107	TAR009	KTARMV103	TAR009		
KTARHO108	TAR009	KTARMV104	TAR025		
KTARHO109	TAR009	KTARMV105	TAR009		
KTARHO110	TAR009	KTARMV106	TAR025		
KTARHO111	TAR009	<b>SUZUKI</b>			
KTARHO112	TAR009	KTARSU101	TAR009		
KTARHO113	TAR009	KTARSU102	TAR029		
KTARHO114	TAR025	KTARSU104	TAR009		
KTARHO115	TAR025	KTARSU109	TAR009		
KTARHO116	TAR025	KTARSU110	TAR009		
KTARHO117	TAR025	KTARSU111	TAR009		
KTARHO118	TAR025	KTARSU112	TAR009		
KTARHO119	TAR025	KTARSU113	TAR025		
KTARHO120	TAR025	KTARSU114	TAR025		
KTARHO121	TAR025	KTARSU115	TAR025		
KTARHO122	TAR009	KTARSU117	TAR009		

			pour kit / kit
Kits vis / Schrauben Sets	005M8x25 + RCM8	TAR 009	€ 9,20
Kits vis / Schrauben Sets	005M8x30 + RCM8	TAR 029	€ 9,20
Kits vis / Schrauben Sets	005M8x35 + RCM8	TAR 008	€ 9,20
Kits vis / Schrauben Sets	005M8x40 + RCM8	TAR 025	€ 9,20



**FEUX**  
BELEUCHTUNG



## CLIGNOTANT À LED

130 BLINKER

*Katana*



FEU SÉQUENTIEL / SEQUENTIELLES LIGHT

### Paire de clignotants a LED / Paar Led Blinker

**Matiere / Material:** ABS  
**Homologué / Homologiert**

- Nouveaux indicateurs de direction / Neue Blinker
- Lightech patented / Lightech patented
- Technologie innovante MULTI-PIXEL / Innovative MULTI-PIXEL-Technologie

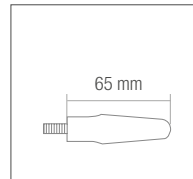

### ■ Clignotants / Blinker

FRE933NER

pour la paire/1 Paar

€ 56,10

SeagullWing



### Paire de clignotants a LED / Paar Led Blinker

**Matiere / Material:** ABS  
**Homologué / Homologiert:** E8

- Nouveaux indicateurs de direction / Neue Blinker
- Lightech patented / Lightech patented
- Technologie innovante MULTI-PIXEL / Innovative MULTI-PIXEL-Technologie

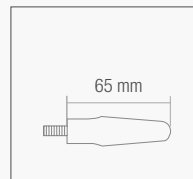

### ■ Clignotants / Blinker

FRE931NER

pour la paire/1 Paar

€ 56,10



### MonsterEye 1



#### Paire de clignotants a LED / Paar Led Blinker

**Matiere / Material:** ABS  
**Homologué / Homologiert:** E8

- Nouveaux indicateurs de direction / Neue Blinker
- Lightech patented / Lightech patented
- Technologie innovante MULTI-PIXEL / Innovative MULTI-PIXEL-Technologie

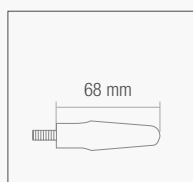

#### ■ Clignotants / Blinker

FRE932NER

pour la paire/1 Paar

€ 56,10

### MonsterEye 2



#### Paire de clignotants a LED / Paar Led Blinker

**Matiere / Material:** ABS  
**Homologué / Homologiert:**

- Nouveaux indicateurs de direction / Neue Blinker
- Lightech patented / Lightech patented
- Technologie innovante MULTI-PIXEL / Innovative MULTI-PIXEL-Technologie

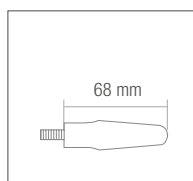

#### ■ Clignotants / Blinker

□ Front WHITE Light

FRE934NER

pour la paire/1 Paar

€ 59,50

### MonsterEye 3



#### Paire de clignotants a LED / Paar Led Blinker

**Matiere / Material:** ABS  
**Homologué / Homologiert:**

- Nouveaux indicateurs de direction / Neue Blinker
- Lightech patented / Lightech patented
- Technologie innovante MULTI-PIXEL / Innovative MULTI-PIXEL-Technologie

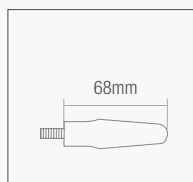

#### ■ Clignotants / Blinker

■ Rear RED Light / Brake Light

FRE935NER

pour la paire/1 Paar

€ 59,50

# CLIGNOTANT À LED

132 BLINKER



NEW!

## Paire de clignotants a LED / Paar Led Blinker

**Matiere / Material:** ABS  
**Homologué / Homologiert**

- Nouveaux indicateurs de direction / Neue Blinker
- Technologie innovante MULTI-PIXEL / Innovative MULTI-PIXEL-Technologie

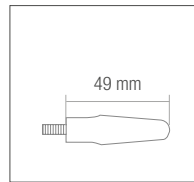

### ■ Clignotants / Blinker

FRE936NER

pour la paire/1 Paar

€ 52,70



NEW!

## Paire de clignotants a LED / Paar Led Blinker

**Matiere / Material:** ABS  
**Homologué / Homologiert**

- Nouveaux indicateurs de direction / Neue Blinker

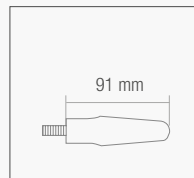

### ■ Clignotants / Blinker

□ Front WHITE Light

FRE937NER

pour la paire/1 Paar

€ 55,00



**Paire de clignotants a LED / Paar Led Blinker**

Matiere / Material: ABS  
Homologué / Homologiert

• Nouveaux indicateurs de direction / Neue Blinker

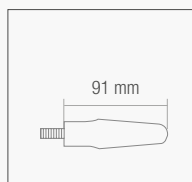

- Clignotants / Blinker
- Rear RED Light / Brake Light

FRE938NER

pour la paire/1 Paar

€ 56,10



FRE934NER

# CLIGNOTANT À LED

134 BLINKER

B52



## Paire de clignotants a LED / Paar Led Blinker

Matiere / Material: ABS  
Homologué / Homologiert: E8

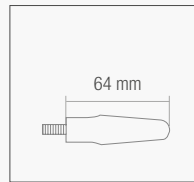

■ Clignotants / Blinker

FRE929NER

pour la paire/1 Paar

€ 56,10

TheTube



## Paire de clignotants a LED / Paar Led Blinker

Matiere / Material: aluminum  
Homologué / Homologiert: E8

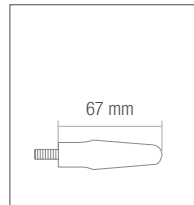

■ Clignotants / Blinker

FRE930NER ■  
FRE930COB ■  
FRE930ROS ■

pour la paire/1 Paar

€ 61,80

! FINE DE LA SÉRIE - AUSLAUFARTIKEL

FRE930NER







FEU SÉQUENTIEL / SEQUENTIELLES LICHT

Paire de clignotants a LED / Paar Led Blinker

Matiere / Material: ABS  
Homologué / Homologiert: E8

- Clignotants / Blinker
- Feu stop / Bremslicht
- Rear RED Light / Brake Light

FRE923NER

pour la paire/1 Paar

€ 55,00

! FINE DE LA SÉRIE - AUSLAUFARTIKEL

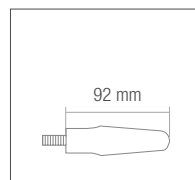

FEU SÉQUENTIEL / SEQUENTIELLES LICHT

Paire de clignotants a LED / Paar Led Blinker

Matiere / Material: ABS  
Homologué / Homologiert: E8

- Clignotants / Blinker

FRE925NER

pour la paire/1 Paar

€ 56,10

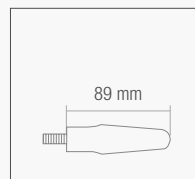

# CLIGNOTANT À LED

136 BLINKER

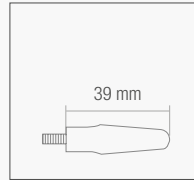

## Paire de clignotants a LED / Paar Led Blinker

Matiere / Material: ABS  
Homologué / Homologiert: E8

### ■ Clignotants / Blinker

FRE928NER

pour la paire/1 Paar

€ 44,60

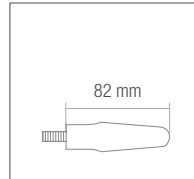

## Paire de clignotants a LED / Paar Led Blinker

Matiere / Material: ABS  
Homologué / Homologiert: E8

### ■ Clignotants / Blinker

FRE926NER

pour la paire/1 Paar

€ 43,50

! FINE DE LA SÉRIE - AUSLAUFARTIKEL

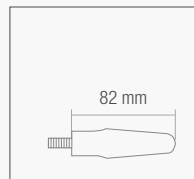

## Paire de clignotants a LED / Paar Led Blinker

Matiere / Material: ABS  
Homologué / Homologiert: E8

### ■ Clignotants / Blinker

FRE922NER

pour la paire/1 Paar

€ 44,60



Support de clignotant à led  
Adapter für Blinker

PFY € 14,40

pour 4 pièces  
4 Stücke



Support de clignotant à led  
Adapter für Blinker

PFK € 14,40

pour 4 pièces  
4 Stücke



Support de clignotant à led  
Adapter für Blinker

PFH2 € 14,40

pour 4 pièces  
4 Stücke



Support de clignotant à led  
Adapter für Blinker

PFS € 14,40

pour 4 pièces  
4 Stücke



Support de clignotant à led  
Adapter für Blinker

PFK2 € 16,60

pour 4 pièces  
4 Stücke



**PLAQUES DE CLIGNOTANTS**

138 PLATTEN FÜR BLINKER



Nouveau expositeur pour indicateurs de direction  
Neuer Aufsteller für Blinker

EXP009



! Not included

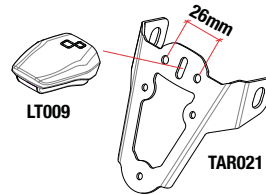

100% MADE IN ITALY  
PATENTED DESIGN®  
HOMOLOGATED



Éclairage de plaque Python  
Python Kennzeichenbeleuchtung

LT009BIA

LT009NER

! FINE DE LA SÉRIE - AUSLAUFARTIKEL

LT009BLU

! FINE DE LA SÉRIE - AUSLAUFARTIKEL

€ 35,10



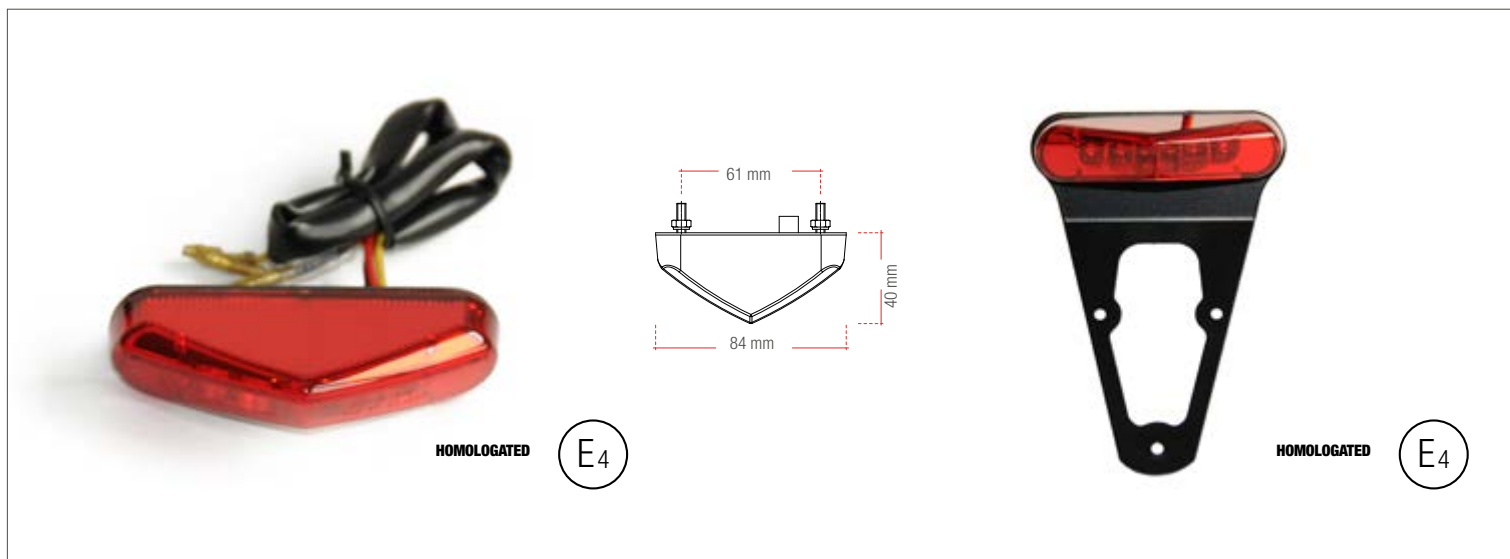

Feu arrière avec éclairage de plaque d'immatriculation + STOP Rücklicht mit Kennzeichenleuchte + STOP	LT007	€ 41,70
--	-------	---------

Feu arrière avec éclairage de plaque d'immatriculation + STOP Rücklicht mit Kennzeichenleuchte + STOP	LT008	€ 53,00
--	-------	---------

avec couverture phare / mit Aluminium Halter



Feu arrière avec éclairage de plaque d'immatriculation + STOP Rücklicht mit Kennzeichenleuchte + STOP	LT003	€ 38,10
--	-------	---------

sans couverture phare / ohne Aluminium Halter

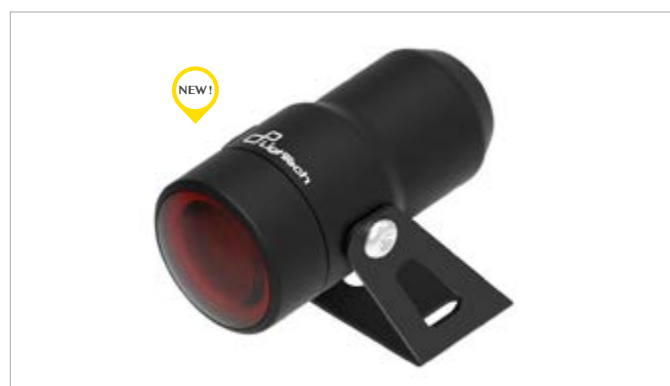

Feu arrière "RAIN" Rücklicht "RAIN"	LT011	€ 74,40
--	-------	---------

**NOT HOMOLOGATED**



Kit résistance - Kit Widerstand  
10W / 6 ohm  
FRERES € 7,50



Kit résistance - Kit Widerstand  
25W / 10 ohm  
FRE002 € 10,60



Kit résistance - Kit Widerstand  
5W / 22 ohm  
FRE001 € 8,20



Kit résistance - Kit Widerstand  
10w - 27 ohm  
FRE003 € 8,20



Kit résistance - Kit Widerstand  
21w - 8 ohm  
FRE004 € 8,20



Kit résistance - Kit Widerstand  
21 w - 10 ohm  
FRE005 € 8,20



Relais électronique / elektronisches Relais  
FRE010 € 13,90  
Intermittence fixe /  
blinkende Funktion fest  
12v -180w - 15A



Relais électronique / elektronisches Relais  
FRE011 € 24,00  
Intermittence réglable /  
verstellbare blinkende Funktion  
12v (0,6 -> 180w) - 0,05 - 15A



Kit résistance - Kit Widerstand  
FRE012 € 20,20  
Intermittence fixe /  
blinkende Funktion fest  
12,8v - (1-> 100w) - 10A



Relais électronique / elektronisches Relais  
FRE013 € 24,00  
Intermittence fixe / blinkende Funktion fest  
Spécifique pour / Passend für : Honda  
12,8v / 1 - 1 00w



Relais électronique / elektronisches Relais  
FRE014 € 16,30  
Intermittence fixe /  
blinkende Funktion fest  
Spécifique pour / Passend für : Honda Honda, Kawasaki, Yamaha  
12v (0,6v -> 120w) - 0,05 - 10A



Kit résistance - Kit Widerstand  
FRE015 € 28,30  
Intermittence fixe /  
blinkende Funktion fest  
Spécifique pour / Passend für: Suzuki Plug & Play  
(12->13,8v) 1->100w



Jeu d'adaptateurs Honda  
Adapter-kit Honda

FRE006

€ 8,20



Jeu d'adaptateurs Yamaha  
Adapter-kit Yamaha

FRE007

€ 8,20



Jeu d'adaptateurs Suzuki  
Adapter-kit Suzuki

FRE008

€ 8,20



Jeu d'adaptateurs Kawasaki  
Adapter-kit Kawasaki

FRE009

€ 8,20



Jeu d'adaptateurs BMW  
Adapter-kit BMW

FRE016

€ 16,30



Jeu d'adaptateurs Triumph  
Adapter-kit Triumph

FRE017

€ 16,30

NEW!



Jeu d'adaptateurs Honda  
Adapter-kit Honda

FRE018

€ 12,00

Avec résistances intégrées - Mit integrierten Widerständen

NEW!



Jeu d'adaptateurs Honda  
Adapter-kit Honda

FRE019

€ 8,20

Avec résistances intégrées - Mit integrierten Widerständen

NEW!



Jeu d'adaptateurs Honda  
Adapter-kit Honda

FRE020

€ 20,20

Avec résistances intégrées - Mit integrierten Widerständen

NEW!



Jeu d'adaptateurs Suzuki & Yamaha  
Adapter-kit Suzuki & Yamaha

FRE021

€ 8,20

NEW!



Jeu d'adaptateurs Suzuki & Yamaha  
Adapter-kit Suzuki & Yamaha

FRE022

€ 8,20

Avec résistances intégrées - Mit integrierten Widerständen



BORN  
TO BE  
MOTO







**PROTECTION EN  
ALUMINIUM**  
ALUMINIUM  
PROTEKTOREN

Modèl - Modell	Année- Jahr		Article - Artikel	Code - Code	€
----------------	-------------	--	-------------------	-------------	---

du - von au - bis

<b>APRILIA</b>					
RS 660	20	22	Protection Carter Alternateur Côté L / Lichtmaschine Deckel Seite L	ECPAP004	<b>131,70</b>
			Protection Carter Embrayage Côté R / Kupplungs - Deckel Seite R	ECPAP003	<b>217,50</b>
RSV4 R / RR / Factory / APRC / RF	09	20	Protection Carter Alternateur Côté L / Lichtmaschine Deckel Seite L	ECPAP001	<b>116,70</b>
			Protection Carter Embrayage Côté R / Kupplungs - Deckel Seite R	ECPAP002	<b>235,90</b>
RSV4 1100 Factory	21	22	Protection Carter Alternateur Côté L / Lichtmaschine Deckel Seite L	ECPAP005	<b>116,70</b>
			Protection Carter Embrayage Côté R / Kupplungs - Deckel Seite R	ECPAP002	<b>235,90</b>
Tuono R / RR / Factory / APRC / RF	11	20	Protection Carter Alternateur Côté L / Lichtmaschine Deckel Seite L	ECPAP001	<b>116,70</b>
			Protection Carter Embrayage Côté R / Kupplungs - Deckel Seite R	ECPAP002	<b>235,90</b>
Tuono 1100 Factory	21	22	Protection Carter Alternateur Côté L / Lichtmaschine Deckel Seite L	ECPAP005	<b>116,70</b>
			Protection Carter Embrayage Côté R / Kupplungs - Deckel Seite R	ECPAP002	<b>235,90</b>

<b>BMW</b>					
S 1000 R	09	20	Protection Carter Alternateur Côté L / Lichtmaschine Deckel Seite L	ECPBM001	<b>178,60</b>
			Couvre Pick Up Côté R / Pick Up Deckel Seite R	ECPBM003	<b>81,30</b>
S 1000 R	21	22	Protection Carter Alternateur Côté L / Lichtmaschine Deckel Seite L	ECPBM002	<b>103,00</b>
			Couvre Pick Up Côté R / Pick Up Deckel Seite R	ECPBM004	<b>219,80</b>
S 1000 RR	09	18	Protection Carter Alternateur Côté L / Lichtmaschine Deckel Seite L	ECPBM001	<b>178,60</b>
			Couvre Pick Up Côté R / Pick Up Deckel Seite R	ECPBM003	<b>81,30</b>
S 1000 RR	19	22	Protection Carter Alternateur / Lichtmaschine Deckel	ECPBM002	<b>103,00</b>
			Protection Carter Pick Up - Embrayage / Kupplungs Pick Up - Deckel	ECPBM004	<b>219,80</b>

NEW!



ECPAP003

NEW!



ECPAP004



ECPAP001  
ECPAP005



ECPAP002

ECPBM002



ECPBM004



ECPBM001



ECPBM003

FINE DE LA SÉRIE - AUSLAUFARTIKEL

Modèl - Modell	Année - Jahr		Article - Artikel	Code - Code	€
----------------	--------------	--	-------------------	-------------	---

du - von au - bis

<b>DUCATI</b>					
848 / 1098 / 1198 SBK	07	11	Protection pomp à eau / Wasserpumpenabdeckung	WPPDU002	101,30
Hypermotard 796 / 1100	07	12	Protection pomp à eau / Wasserpumpenabdeckung	WPPDU002	101,30
Hypermotard 821 / Hyperstrada 821	13	16	Couvre pignon / Vordere Zahnradabdeckung	<b>ECPDU004</b>	<b>84,20</b>
			Protection pomp à eau / Wasserpumpenabdeckung	WPPDU002	101,30
Hypermotard 939 / 950	17	22	Protection pomp à eau / Wasserpumpenabdeckung	WPPDU003	101,30
Monster 821	14	20	Protection pomp à eau / Wasserpumpenabdeckung	WPPDU003	101,30
Monster 1200	13	16	Protection pomp à eau / Wasserpumpenabdeckung	WPPDU002	101,30
	17	20	Protection pomp à eau / Wasserpumpenabdeckung	WPPDU003	101,30
Multistrada 950 / S	19	21	Protection pomp à eau / Wasserpumpenabdeckung	WPPDU003	101,30
Multistrada 1200	07	14	Protection pomp à eau / Wasserpumpenabdeckung	WPPDU002	101,30
	15	19	Protection pomp à eau / Wasserpumpenabdeckung	WPPDU003	101,30
Panigale 1199	12	15	Protection Carter Alternateur Côté L / Lichtmaschine Deckel Seite L	ECPDU001	196,90
			Protection Carter Embrayage Côté R / Kupplungs - Deckel Seite R	ECPDU002	178,60
Panigale V4	18	21	Protection Carter Alternateur Côté L / Lichtmaschine Deckel Seite L	ECPDU007	196,90
			Protection Carter Embrayage Côté R / Kupplungs - Deckel Seite R	ECPDU006	178,60
Streetfighter 848 / 1100	09	16	Protection pomp à eau / Wasserpumpenabdeckung	WPPDU002	101,30
Streetfighter V4	20	22	Protection Carter Alternateur Côté L / Lichtmaschine Deckel Seite L	ECPDU007	196,90

<b>HONDA</b>					
CBR1000 RR-R / SP	20	22	Couvre Pick Up Côté R / Pick Up Deckel Seite R	ECPDU006	196,90
			Protection Carter Alternateur Côté L / Lichtmaschine Deckel Seite L	ECPDU007	167,20



ECPDU006



ECPDU007



WPPDU003



ECPDU006



ECPDU007



ECPKA001



ECPKA002



ECPMV002

Modèl - Modell	Année- Jahr		Article - Artikel	Code - Code	€
du - von      au - bis					
<b>KAWASAKI</b>					
Ninja 300	13	17	Protection Carter Alternateur Côté L / Lichtmaschine Deckel Seite L	ECPKA004	<b>111,00</b>
			Protection Carter Embrayage Côté R / Kupplungs - Deckel Seite R	ECPKA003	<b>146,60</b>
ZX 10R	11	22	Couvre Pick Up Côté R / Pick Up Deckel Seite R	ECPKA001	<b>116,70</b>
			Protection Carter Alternateur Côté L / Lichtmaschine Deckel Seite L	ECPKA002	<b>152,30</b>
<b>MV AGUSTA</b>					
B3 675 / 800	12	17	Protection Carter Alternateur Côté L / Lichtmaschine Deckel Seite L	ECPMV003	<b>137,40</b>
		15	Protection Carter Embrayage Côté R / Kupplungs - Deckel Seite R	ECPMV004	<b>172,90</b>
F3 675 / 800	12	17	Protection Carter Alternateur Côté L / Lichtmaschine Deckel Seite L	ECPMV003	<b>137,40</b>
		15	Protection Carter Embrayage Côté R / Kupplungs - Deckel Seite R	ECPMV004	<b>172,90</b>
Dragster 800	14	17	Protection Carter Alternateur Côté L / Lichtmaschine Deckel Seite L	ECPMV003	<b>137,40</b>
		15	Protection Carter Embrayage Côté R / Kupplungs - Deckel Seite R	ECPMV004	<b>172,90</b>
Rivale 800	14	17	Protection Carter Alternateur Côté L / Lichtmaschine Deckel Seite L	ECPMV003	<b>137,40</b>
		15	Protection Carter Embrayage Côté R / Kupplungs - Deckel Seite R	ECPMV004	<b>172,90</b>
<b>SUZUKI</b>					
GSXR 1000	17	22	Protection Carter Alternateur Côté L / Lichtmaschine Deckel Seite L	ECPSU006	<b>208,30</b>



ECPSU006



ECPYA008



ECPYA009



ECPYA004



ECPYA005





ECPYA006



ECPYA011



ECPYA012

Modèl - Modell	Année- Jahr		Article - Artikel	Code - Code	€
du - von      au - bis					
<b>YAMAHA</b>					
MT-10	16	21	Protection Carter Alternateur Côté L / Lichtmaschine Deckel Seite L	ECPYA004	160,30
			Protection Carter Embrayage Côté R / Kupplungs - Deckel Seite R	ECPYA005	172,90
			Couvre Pick Up Côté R / Pick Up Deckel Seite R	ECPYA006	113,30
R1 / R1M	15	22	Protection Carter Alternateur Côté L / Lichtmaschine Deckel Seite L	ECPYA004	160,30
			Protection Carter Embrayage Côté R / Kupplungs - Deckel Seite R	ECPYA005	172,90
			Couvre Pick Up Côté R / Pick Up Deckel Seite R	ECPYA006	113,30
R6	06	22	Protection Carter Alternateur Côté L / Lichtmaschine Deckel Seite L	ECPYA001	167,10
			Protection Carter Embrayage Côté R / Kupplungs - Deckel Seite R	ECPYA009	194,60
			Couvre Pick Up Côté R / Pick Up Deckel Seite R	ECPYA008	137,40
R7	22	22	Protection Carter Alternateur Côté L / Lichtmaschine Deckel Seite L	ECPYA011	xxx
			Protection Carter Embrayage Côté R / Kupplungs - Deckel Seite R	ECPYA012	xxx
T-Max 500 - 530	06	16	Kit protection carter / Carter Abdeckungssatz	STEYA002	143,10
T-Max 530 - 560	17	21	Kit protection carter / Carter Abdeckungssatz <span style="color: black;">■</span> <span style="color: red;">■</span> <span style="color: yellow;">■</span> <span style="color: blue;">■</span>	ECPYA010	219,80



BORN  
TO BE  
MOTO





**SP**  
**TRIPLE**

**PROTECTION**  
**PROTEKTOREN**

LightTech

LightTech

LightTech



Couleur disponible: noir. Verfügbare Farbe: Schwarz

Right = droite / Rechts Left = gauche / Links ø = trou intérieur boîte de l'essieu / Innere Loch Durchmesser

FINE DE LA SÉRIE - AUSLAUFARTIKEL

Modèle - Modell	percer carène bohrung nicht notwendig	Année - Jahr		ø mm	Code - Code	€
-----------------	--	--------------	--	------	-------------	---

du - von au - bis

APRILIA						
Dorsoduro 750 / 1200	/	08	17	10	STEAP201	88,10
Dorsoduro 900	/	18	20	10	STEAP201	88,10
RSV4 / Factory / APRC voir page 154 / siehe Seite 154	/	09	14	-	STEAP104	158,00
RSV4 / Factory / APRC voir page 154 / siehe Seite 154	/	09	14	-	STEAP105	158,00
RSV4 / APRC / RF / 1100 Factory voir page 154 / siehe Seite 154	/	15	20	-	STEAP107	158,00
Shiver 750	/	07	16	10	STEAP201	88,10
Shiver 900	/	18	20	10	STEAP201	88,10
Tuono V4	/	11	20	10	STEAP203	100,80
Tuono V4 voir page 154 / siehe Seite 154	/	11	20	-	STEAP106	158,00
Tuono V4 1100 Factory	/	21	22	10	STEAP204	95,00

NEW!

BENELLI						
Leoncino	/	18	21	10	STEBN201	88,10

BMW						
R Nine-T Scrambler	/	16	19	-	STEBM207	43,50
S1000RR	/	09	11	10	STEBM201	85,90
S1000RR / HP4	/	12	14	10	STEBM205	108,80
S1000RR	/	15	18	10	STEBM206	108,80
S1000RR	/	19	22	10	STEBM208	183,20





FINE DE LA SÉRIE - AUSLAUFARTIKEL

Modèle - Modell	percer carène bohrung nicht notwendig	Année - Jahr		ø mm	Code - Code	€
		du - von	au - bis			
<b>DUCATI</b>						
Hypermotard 796	/	09	12	10	STEDU205	88,10
Hypermotard 821 / Hyperstrada 821	/	13	16	10	STEDU206	88,10
Monster 696 / 796 / 1100	/	08	14	10	STEDU202	88,10
Scrambler	/	14	16	10	STEDU207	97,30
Streetfighter 848	/	11	16	10	STEDU205	88,10
Streetfighter 1100	/	09	15	10	STEDU203	88,10
<b>HONDA</b>						
CB 500 F	/	13	22	10	STEH0213	85,90
CB 650 F	/	17	18	12	STEH0215	85,90
CB 650 R	/	19	22	12	STEH0215	85,90
CB 1000 R	/	08	22	12	STEH0211	85,90
CBF 1000	/	06	12	12	STEH0211	85,90
CBR 600 F	right / left	11	13	12	STEH0201	85,90
CBR 600 RR	right / left	03	06	12	STEH0201	85,90
CBR 600 RR	right / left	09	13	12	STEH0203	85,90
CBR 1000 RR	/	06	07	10	STEH0208	115,60
CBR 1000 RR	right / left	08	16	12	STEH0209	85,90
CBR 1000 RR-R / SP	/	20	22	12	STEH0216	85,90
Hornet 600	/	03	06	10	STEH0204	88,10
Hornet 600	/	07	13	12	STEH0205	85,90
<b>HUSQVARNA</b>						
Nuda 900	/	12	15	12	STEHU201	85,90
<b>KAWASAKI</b>						
ER - 6N	/	12	16	10	STEKA211	117,90
Ninja 650	/	21	22	10	STEKA218	85,90
Z125	/	19	22	10	STEKA216	85,90
Z650	/	17	21	10	STEKA214	85,90
Z650	/	22	22	10	STEKA217	85,90
Z750	/	04	06	10	STEKA205	85,90
Z750	/	07	12	10	STEKA206	85,90
Z800	/	13	16	-	STEKAT12NER	■ 141,90
Z800	/	13	16	-	STEKAT12SIL	■ 141,90
Z800	/	13	16	-	STEKAT12ROS	■ 141,90
Z900	/	17	22	10	STEKA215	85,90
Z1000	/	03	06	10	STEKA205	85,90
Z1000	/	07	09	10	STEKA206	85,90
Z1000	/	10	20	10	STEKA207	85,90
ZX6R	right / left	05	06	10	STEKA202	85,90
ZX6R	/	07	08	10	STEKA203	100,70
ZX6R / 636	/	13	21	10	STEKA213	100,70
ZX10R	left	08	10	10	STEKA204	85,90
ZX10R	/	11	22	10	STEKA210	88,10

NEW!

Modèle - Modell	percer carène bohrung nicht notwendig	Année - Jahr		ø mm	Code - Code	€
		du - von	au - bis			
<b>KTM</b>						
Duke 125	/	17	21	10	STEKT203	123,60
Duke 390	/	17	22	10	STEKT203	123,60
Duke 790	/	18	21	10	STEKT204	123,60
Duke 890 / L / R	/	20	22	10	STEKT204	123,60
<b>MV</b>						
Brutale 675 / 800	/	12	16	10	STEMV202	88,10
Brutale 800	/	17	18	12	STEMV203	88,10
Brutale 750 / 910 / 1000 / 1090	/	01	12	13	STEMV201	93,90
Dragster 800	/	13	16	10	STEMV202	88,10
Dragster 800	/	17	18	12	STEMV203	88,10
Rivale 800	/	13	16	10	STEMV202	88,10
<b>SUZUKI</b>						
Gladius 650	/	09	15	10	STESU209	97,30
GSR 600	/	06	11	10	STESU208	85,90
GSR 750	/	11	16	10	STESU211	85,90
GSXR 600 / 750	/	08	10	10	STESU202	103,00
GSXR 600 / 750	/	11	17	10	STESU210	117,90
GSXR 1000	/	07	08	10	STESU205	85,90
GSXR 1000	/	09	16	10	STESU206	117,90
GSXR 1000	/	17	22	10	STESU215	153,40
GSX-S 750	/	17	20	10	STESU214	85,90
GSX-S 950	/	21	22	10	STESU212	85,90
GSX-S 1000	/	15	22	10	STESU212	85,90
Katana	/	20	22	10	STESU212	85,90
SV 650	/	16	21	10	STESU213	85,90
<b>TRIUMPH</b>						
Street Triple 675 / 675R	/	07	10	10	STETR203	85,90
Street Triple 675 / 675R	/	11	16	10	STETR205	85,90
Street Triple 765 / 765R / 765RS	/	17	22	10	STETR205	85,90
Speed Triple 1050	/	08	10	12	STETR202	85,90
Speed Triple 1050	/	11	16	12	STETR204	85,90
Speed Triple RS 1200	/	21	22	10	STETR206	85,90
<b>YAMAHA</b>						
FAZER 600 / FZ6	/	04	12	10	STEYA205	85,90
FZ1	/	06	15	10	STEYA206	85,90
FZ8	/	10	15	10	STEYA206	85,90
MT-03	/	06	14	10	STEYA208	115,60
MT-03 ( cc 300)	/	15	21	10	STEYA217	85,90
MT-07	/	14	21	10	STEYA212	85,90
MT-09	/	13	16	10	STEYA211	85,90
MT-09 / SP	/	17	20	10	STEYA215	85,90
MT-09 / SP	/	21	22	10	STEYA218	85,90
MT-09 Tracer / XSR 900	/	13	20	10	STEYA211	85,90
MT-10	/	16	21	12	STEYA213	85,90
R1/ R1-M	/	15	22	12	STEYA213	85,90
R3	/	15	18	10	STEYA214	85,90
R6	/	06	07	10	STEYA203	97,30
R6	/	08	16	10	STEYA204	97,30
R6	/	17	22	10	STEYA216	200,30
R7	/	22	22	10	STEYA219	97,30



BAGUES EN ALUMINIUM ES 7 COULEURS

ALUMINIUM RINGE IN 7 FARBEN



RSTE102ARA

RSTE102ROS

RSTE102ORO

RSTE102VER

RSTE102COB

RSTE102NER

RSTE102SIL

€ 11,90

pour la paire/1 Paar

GOMME POUR PROTECTION DE CADRE

GUMMISHOCKABSORBER FÜR RAHMENPROTEKTOREN



RSTE101ARA

RSTE101BLU

RSTE101ROS

RSTE101VER

RSTE101NER

RSTE101BIA

€ 10,60

pour la paire/1 Paar



PIÈCES DÉTACHÉES POUR VERSION "200"

ERSATZTEIL FÜR NEUE SERIE "200"

a pièce - 1 Stück

Recharge protection de cadre / Ersatzteile für Protektoren	ø10	RSTE210	€ 28,10
Recharge protection de cadre / Ersatzteile für Protektoren	ø12	RSTE212	€ 28,10
Recharge protection de cadre / Ersatzteile für Protektoren	ø13	RSTE213	€ 28,10



\* Verifier position vis / Position der Schraube überprüfen

**APRILIA RSV4**



Code: STEAP104

- Position haute
- Position oben



Code: STEAP105

- Position au centre
- Position mittig



Code: STEAP107

- Position inférieure
- Position unten



**APRILIA TUONO V4**

Code: STEAP106

- Position au centre
- Position mittig



APRILIA RSV4







**PROTECTION  
AXE DE ROUE  
RADACHSE  
PROTEKTOREN**

**NEW LOOK**

- Insert smart plug  
Smart Plug Insert
- Combinaisons de couleurs dédiées  
Spezielle Farbkombinationen

Meilleure protection contre les chocs  
Höher Aufprallschutz

Evolution des lignes  
Entwicklung des Design



- rouge  
Rot
- cobalt  
Kobalt
- noir  
Schwarz
- or  
Gold
- argent  
Silber
- vert  
Grün
- orange  
Orange

Modèle - Modell		Année - Jahr		Code - Code	€	Front / Rear
		du - von	au - bis			
<b>APRILIA</b>						
Dorsoduro 750 / 1200	<span style="color: red;">■</span> <span style="color: black;">■</span> <span style="color: gold;">■</span> <span style="color: silver;">■</span>	08	17	WAPAP401	<b>66,40</b>	F+R
Dorsoduro 900	<span style="color: red;">■</span> <span style="color: black;">■</span> <span style="color: gold;">■</span> <span style="color: silver;">■</span>	18	21	WAPAP401	<b>66,40</b>	F+R
RS 660	<span style="color: red;">■</span> <span style="color: black;">■</span> <span style="color: gold;">■</span>	20	22	WAPAP402	<b>66,40</b>	F+R
RSV4 R / Factory / APRC	<span style="color: red;">■</span> <span style="color: black;">■</span> <span style="color: gold;">■</span> <span style="color: silver;">■</span>	09	22	WAPAP401	<b>66,40</b>	F+R
Shiver 750	<span style="color: red;">■</span> <span style="color: black;">■</span> <span style="color: gold;">■</span> <span style="color: silver;">■</span>	07	16	WAPAP401	<b>66,40</b>	F+R
Tuono V4	<span style="color: red;">■</span> <span style="color: black;">■</span> <span style="color: gold;">■</span> <span style="color: silver;">■</span>	11	22	WAPAP401	<b>66,40</b>	F+R
<b>BMW</b>						
S1000R	<span style="color: red;">■</span> <span style="color: black;">■</span> <span style="color: blue;">■</span> <span style="color: silver;">■</span>	14	19	WAPBM401	<b>66,40</b>	F+R
S1000RR	<span style="color: red;">■</span> <span style="color: black;">■</span> <span style="color: blue;">■</span> <span style="color: silver;">■</span>	09	22	WAPBM401	<b>66,40</b>	F+R
<b>DUCATI</b>						
Diavel	<span style="color: red;">■</span> <span style="color: black;">■</span>	11	17	WAPDU401	<b>54,40</b>	F
Hypermotard 821 / 939 / 959 / 950	<span style="color: red;">■</span> <span style="color: black;">■</span>	13	22	WAPDU403	<b>38,30</b>	F
Monster 821	<span style="color: red;">■</span> <span style="color: black;">■</span>	14	16	WAPDU405	<b>66,40</b>	F+R
Monster 1100	<span style="color: red;">■</span> <span style="color: black;">■</span>	11	13	WAPDU402	<b>38,30</b>	F
Monster 1200 / S / R	<span style="color: red;">■</span> <span style="color: black;">■</span>	14	21	WAPDU403	<b>38,30</b>	F
Multistrada 950 / S	<span style="color: red;">■</span> <span style="color: black;">■</span>	19	21	WAPDU405	<b>66,40</b>	F
Multistrada V2 / S	<span style="color: red;">■</span> <span style="color: black;">■</span>	22	22	WAPDU405	<b>66,40</b>	F
Multistrada V4 / S	<span style="color: red;">■</span> <span style="color: black;">■</span>	21	22	WAPDU405	<b>66,40</b>	F
Panigale 959	<span style="color: red;">■</span> <span style="color: black;">■</span>	15	19	WAPDU408	<b>66,40</b>	F+R
Panigale 1199	<span style="color: red;">■</span> <span style="color: black;">■</span>	12	14	WAPDU401	<b>54,40</b>	F
				ARDU110	<b>101,90</b>	R
Panigale 1299	<span style="color: red;">■</span> <span style="color: black;">■</span>	15	17	WAPDU409	<b>54,40</b>	F
				ARDU110	<b>101,90</b>	R
Panigale 955 V2	<span style="color: red;">■</span> <span style="color: black;">■</span>	21	22	WAPDU409	<b>54,40</b>	F
				ARDU110	<b>101,90</b>	R
Panigale V4 / S	<span style="color: red;">■</span> <span style="color: black;">■</span>	18	22	WAPDU409	<b>54,40</b>	F
				ARDU110	<b>101,90</b>	R
Streetfighter 848	<span style="color: red;">■</span> <span style="color: black;">■</span>	11	16	WAPDU402	<b>38,30</b>	F
Streetfighter 1100	<span style="color: red;">■</span> <span style="color: black;">■</span>	09	15	WAPDU403	<b>38,30</b>	F
Streetfighter V4 / S	<span style="color: red;">■</span> <span style="color: black;">■</span>	20	22	WAPDU409	<b>54,40</b>	F
				ARDU110	<b>101,90</b>	R



Modèle - Modell		Année - Jahr		Code - Code	€	Front / Rear
		du - von	au - bis			
<b>HONDA</b>						
CB 650 F	■ ■	14	15	WAPHO404	38,30	F
CB 1000 R	■ ■	18	21	WAPHO407	38,30	F
CBR 600 RR	■ ■	07	12	WAPHO401	77,80	F+R
CBR 600 RR	■ ■	13	13	WAPHO403	77,80	F+R
CBR 600 RR	■ ■	14	16	WAPHO401	77,80	F+R
CBR 1000 RR	■ ■	08	16	WAPHO402	77,80	F+R
CBR 1000 RR	■ ■	17	19	WAPHO405	77,80	F+R
CBR 1000 RR-R / SP	■ ■	20	22	WAPHO405	77,80	F+R
XADV	■ ■ ■	17	22	WAPHO406	77,80	F+R
<b>KAWASAKI</b>						
Ninja 1000 SX	■ ■ ■	21	22	WAPKA406	38,30	F+R
Z650	■ ■ ■	17	22	WAPKA407	66,40	F+R
Z 800	■ ■ ■	13	16	WAPKA406	38,30	F
Z900	■ ■ ■	17	22	WAPKA408	66,40	F+R
Z 1000 - SX	■ ■ ■	14	20	WAPKA406	38,30	F
ZX6R / 636	■ ■ ■ ■	13	21	WAPKA405	66,40	F+R
ZX10R	■ ■ ■ ■	11	15	WAPKA401	66,40	F+R
ZX10R	■ ■ ■ ■	16	22	WAPKA409	66,40	F+R
<b>KTM</b>						
Duke 790	■ ■ ■	18	21	WAPKT402	66,40	F+R
Duke 890 R	■ ■ ■	20	22	WAPKT402	66,40	F+R
Super Duke 1290	■ ■ ■	17	22	WAPKT401	38,30	F
Super Duke 1290 / R	■ ■ ■	17	22	WAPKT403	101,90	R
<b>MV AGUSTA</b>						
Brutale	■ ■	10	16	WAPMV401	38,30	F
				ARMV102	101,90	R
B3 675 / B3 800	■ ■	12	16	WAPMV401	38,40	F
				ARMV102	101,90	R
F3 675 / F3 800	■ ■	12	16	WAPMV401	38,30	F
				ARMV102	101,90	R
F4	■ ■	10	16	WAPMV401	38,30	F
				ARMV102	101,90	R
Rivale 800	■ ■	14	16	WAPMV401	38,30	F
				ARMV102	101,90	R
<b>SUZUKI</b>						
GSXR 600 / 750	■ ■ ■ ■	06	10	WAPSU401	77,80	F+R
GSXR 600 / 750	■ ■ ■ ■	11	17	WAPSU402	66,40	F+R
GSXR 1000	■ ■ ■ ■	07	11	WAPSU401	77,80	F+R
GSXR 1000	■ ■ ■ ■	12	22	WAPSU405	66,40	F+R
GSX-S 750	■ ■ ■ ■	17	21	WAPSU406	66,40	F+R
GSX-S 1000	■ ■ ■ ■	15	22	WAPSU404	66,40	F+R
<b>TRIUMPH</b>						
Daytona 675 / 675R	■ ■	13	13	WAPTR401	66,40	F+R
Speed Triple RS 1200	■ ■ ■	21	22	WAPTR403	38,30	F
Street Triple 675 / 675R / RS	■ ■	13	16	WAPTR401	66,40	F+R
Street Triple 765 S / 765R / RS	■ ■	17	22	WAPTR402	38,30	F





# PROTECTION AXE DE ROUE

158 RADACHSE PROTEKTOREN

Modèle - Modell		Année - Jahr		Code - Code	€	Front / Rear
		du - von	au - bis			
<b>YAMAHA</b>						
MT-07		14	21	WAPYA403	38,30	F
				ARYA104	77,90	R
MT-09 / Tracer / XSR900		13	16	WAPYA402	66,40	F+R
MT-09 / SP / Tracer GT / Tracer GT		17	20	WAPYA410	66,40	F+R
MT-09 / SP / Tracer GT / Tracer GT		21	22	WAPYA405	66,40	F+R
MT-10		16	21	WAPYA411	66,40	F+R
R1		07	14	WAPYA401	68,70	F+R
R1 / R1M		15	22	WAPYA411	77,90	F+R
R3		15	22	WAPYA413	66,40	F+R
R6		06	16	WAPYA401	38,30	F+R
R6		17	22	WAPYA411	77,90	F+R
R7		22	22	WAPYA414	77,90	F
				ARYA104	66,40	R
T-Max 500		08	11	WAPYA412	38,30	F
T-Max 530		12	14	WAPYA405	66,40	F+R
T-Max 530 / 560		15	22	WAPYA409	77,90	F+R



## PIECES DÉTACHÉES INTERNE POUR LES PROTECTIONS D'AXE DE ROUE LIGHTTECH

INNERE ERSATZTEILE FÜR RADACHSEPROTEKTOR

KWAP001COB	KWAP001ROS	KWAP001VER	KWAP001ORO	KWAP001NER	KWAP001SIL	KWAP001ARA	€ 10,50

pour la paire/1 Paar







**VISSERIE**  
SCHRAUBEN















**VIS SPECIALES EN ERGAL 7075**

SPEZIALSCHRAUBEN ERGAL 7075

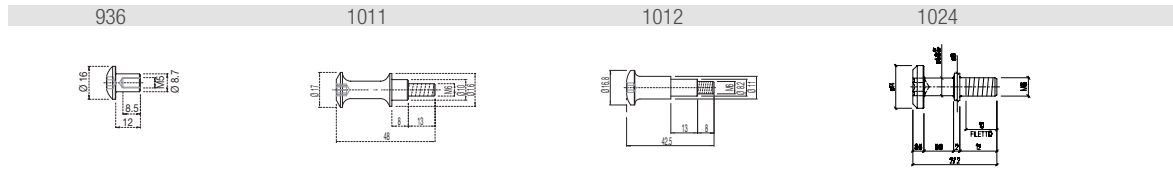
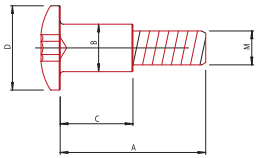

M	A	B	C	D	Code - Code	€
8	38,5	12,4	19	22	930	5,60
10	49	12,4	18,5	22	931	5,60
10	38	12,4	19	22	931B	5,60
4	12	-	-	9	932	2,20
6	19,5	7,5	3,5	14	933	3,60
10	56,5	11,9	22,5	19	934	8,30
8	38,5	11,9	22,5	19	935	7,00
5	12	8,7	12	16	936	6,40
6	17,4	7,9	8,4	17	940	3,60
5	15	7,4	7,5	12	941	3,20
6	20	-	-	10	950	3,60
8	31	10	6	17	951	4,20
8	41	9,9	6	16	952	5,00
8	20	9,9	5	17	953	5,00
6	30	6	9	10	954	3,60
6	23,5	9,9	11	20	955	5,00
6	15	-	-	10	956	3,60
8	33	9,9	11	15	960	4,20
10	25	9,9	4	15	961	4,20
5	16,5	8,1	3,7	14	962	3,20
6	20	7,9	9,5	18	963	3,60
7	17,5	10,9	5,5	24	964	3,60
6	15	7,9	3	14	965	3,60
4	21,5	4	5,5	10	970	2,90
4	7	-	-	10	971	2,50

<b>M</b>	<b>A</b>	<b>B</b>	<b>C</b>	<b>D</b>	<b>Code - Code</b>	<b>€</b>
6	11,5	8,2	3,75	14	972	<b>3,20</b>
6	15	9,85	5	22	974	<b>3,60</b>
6	19	7,9	8	14	976	<b>3,60</b>
6	30,5	8	23,5	14	977	<b>4,20</b>
6	15	7,9	6	14	978	<b>3,60</b>
6	13	6,9	4,4	14	979	<b>2,90</b>
6	14	7,9	3,8	14	980	<b>3,60</b>
5	15,6	7,9	2,6	14	981	<b>3,20</b>
6	16	8,4	3,5	14	982	<b>3,60</b>
6	15	7,9	6	17	983	<b>3,60</b>
6	15	8,9	4	14	984	<b>3,60</b>
6	30	6	11	12	991	<b>3,60</b>
6	11	9,9	3,5	17	992	<b>3,20</b>
5	10	8,9	3	14	993	<b>3,00</b>
6	14,5	9,4	6	17	994	<b>3,60</b>
6	14,5	11,9	3,5	17	995	<b>3,60</b>
6	15	8,9	5	14	997	<b>3,60</b>
6	15	9,9	3,5	17	998	<b>3,20</b>
5	15	7	2,5	11,5	999	<b>3,60</b>
6	15	9	2	14	1000	<b>3,60</b>
5	20,5	7	13,5	12	1001	<b>3,60</b>
5	20,5	6,9	2,5	12	1002	<b>3,60</b>
6	11	8,2	4	14	1003	<b>3,60</b>
6	14	7,9	5,5	14	1004	<b>6,50</b>
6	15	9,8	5,5	22	1005	<b>3,30</b>
10	40	10	5	16	1006	<b>4,20</b>
6	20	6	1,5	30	1007	<b>5,60</b>
6	25,5	8	13,5	17	1008	<b>4,20</b>
5	25	-	-	9	1009	<b>3,60</b>
6	21	10	8	17	1011	<b>5,40</b>
6	21	8,25	13	17	1012	<b>5,40</b>
6	25,5	8	10,5	24	1013	<b>5,40</b>
5	16	8,2	8	14	1015	<b>3,60</b>
6	16,5	8,5	3,5	17	1016	<b>3,70</b>
6	16,5	8,2	5	12	1018	<b>3,70</b>
6	20	9,8	8,6	17	1019	<b>4,20</b>
5	17	8,2	5,8	14	1020	<b>3,70</b>
6	20	8,7	9,2	14	1021	<b>4,20</b>
5	12,8	8,1	3,7	14	1022	<b>3,20</b>
5	11	8	2,6	14	1023	<b>3,60</b>
6	-	-	-	-	1024	<b>4,30</b>
					1027	<b>3,20</b>
					1028	<b>3,20</b>
5	-	-	-	10	1030	<b>3,00</b>
5	17	7,4	5,5	12	1031	<b>3,20</b>
5	20	7,4	9,5	12	1032	<b>3,20</b>
8	25	11,9	10	19	1033	<b>5,00</b>
6	16,5	8,6	3,5	17	1034	<b>4,20</b>
6	20	8,5	10	17	1035	<b>4,20</b>
5	13	8	-	12	1036	<b>3,20</b>
5	17	8,5	6	12	1037	<b>3,20</b>

rouge Rot cobalt Kobalt noir Schwarz or Gold argent Silber

Vis percées - gelochte Schrauben

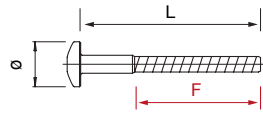

	longueur - Länge	ø tête - Schrauben Kopf	Code - Code	€
M5	15	12	FORM515	5,60
M5	20	12	FORM520	5,70
M6	15	17	FORM615	6,50
M6	20	17	FORM620	6,60
M6	25	17	FORM625	6,80
M6	30	17	FORM630	6,90
M8	20	22	FORM820	7,00
M8	30	22	FORM830	7,30
M8	40	22	FORM840	7,60
M8	45	22	FORM845	7,70

rouge Rot cobalt Kobalt noir Schwarz or Gold argent Silber

Vis à pointe - Schrauben mit Spitze



PAC 2

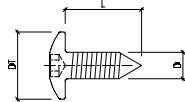

ø	longueur - Länge	ø tête - Schrauben Kopf	Code - Code	€
4,5	13	10	PAC24513	3,90
4,5	16	10	PAC24516	4,10
4,9	13	10	PAC24913	3,90
4,9	16	10	PAC24916	4,10
5,5	16	10	PAC25516	4,10
5,5	19	10	PAC25519	4,30



PAC 3

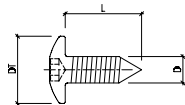

4,5	13	14	PAC34513	3,90
4,5	16	14	PAC34516	4,10
4,9	13	14	PAC34913	3,90
4,9	16	14	PAC34916	4,10
5,5	16	14	PAC35516	4,10
5,5	19	14	PAC35519	4,30

rouge Rot cobalt Kobalt noir Schwarz or Gold argent Silber

Ergal 7075 / Vis zeus - Schnellverschlusschrauben aus Ergal 7075

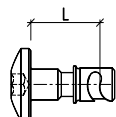

Mesure - Maß	Code - Code	€
11 mm	GR11	6,40
12 mm	GR12	6,40
14 mm	GR14	6,80
16 mm	GR16	7,50
22 mm	GR22	8,40



**Vis zeus en acier** - Schnellverschlusschrauben aus Stahl

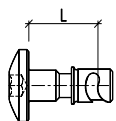

Mesure - Maß	Code - Code	€
11 mm	GRSTTB11	5,60
12 mm	GRSTTB12	5,60
14 mm	GRSTTB14	5,60

**Vis zeus en fer** - Schnellverschlusschrauben aus Eisen

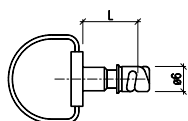

Mesure - Maß	Code - Code	€
11 mm	GRFE11	5,60
12 mm	GRFE12	5,60
14 mm	GRFE14	5,60

**Écroux Zeus** - Schnellverschlussaufnahmen



Code - Code	€
RIC	2,10

■ rouge / Rot  
■ cobalt / Kobalt  
■ noir / Schwarz  
■ or / Gold  
■ argent / Silber

**Bouchon de valve** - Radventildeckel



Code - Code	€
VAL	2,10

# ÉCROUX ER RONDELLES

168 MUTTERN SCHRAUBEN UND UNTERLEGSCHLEIBEN SCHRAUBEN

## Visserie Ergal 7075 - Schrauben aus 7075 Ergal



Nm

Ergal 7075

M3	M4	M5	M6	M8	M10	M12	M14	M16
0,75	1,50	3,00	5,20	12,30	25,00	42,40	67,50	102,5



0011	M4	M5	M6	M8	M10 x 1,25	M10 x 1,5	M12 x 1,25
€	3,20	3,30	3,80	5,00	6,00	6,00	7,00
0012					M10 x 1		
€	-	-	-	-	6,00	-	-
0013							M12 x 1,5
€	-	-	-	-	-	-	7,00



0015	M4	M5	M6	M8			
€	3,20	3,30	3,80	5,00	-	-	-



0016		M5	M6	M8			
€	-	3,30	3,80	5,00	-	-	-



Standard

Mesure - Maß	ø est. ø ext.	épaisseur - Stärke in mm	Code - Code	€
M4	9	0,8	RM4	0,90
M5	10	1,5	RM5	0,90
M6	12	1,6	RM6	0,90
M8	17	1,6	RM8	1,10
M10	21	2	RM10	1,20



Special

Mesure - Maß	ø est. ø ext.	épaisseur - Stärke in mm	Code - Code	€
M5	17	1,6	RSM5A	1,10
M5	21	1,6	RSM5B	1,10
M6	17	1,6	RSM6A	1,10
M6	21	1,6	RSM6B	1,20
M8	21	2	RSM8A	1,20
M10	30	2	RSM10	1,80



Mesure - Maß	ø est. ø ext.	épaisseur - Stärke in mm	Code - Code	€
M5	15	5	RCM5	1,40
M6	22	4	RCM6	1,70
M8	25	5,5	RCM8	2,40

Vits titane degré 5 - Titanschrauben Härtegrad 5



Nm

TIT. 6AV4V G5

M3	M4	M5	M6	M8	M10	M12	M14	M16
1,73	3,57	6,90	11,10	28,30	57,60	97,50	155,20	235,70



T0015	M4	M5	M6	M8	M10 x 1,25	M10 x 1,5	M12 x 1,25
€	6,50	7,60	8,30	11,40	14,90	14,90	20,20



Standard

Mesure - Maß	ø est. ø ext.	épaisseur - Stärke in mm	Code - Code	€
M4	9	0,8	RM4T	2,10
M5	10	1,5	RM5T	2,30
M6	12	1,6	RM6T	2,50
M8	17	1,6	RM8T	3,20
M10	21	2	RM10T	3,80



Special

Mesure - Maß	ø est. ø ext.	épaisseur - Stärke in mm	Code - Code	€
M5	17	1,6	RSM5AT	3,20
M6	17	1,6	RSM6AT	3,20
M6	21	1,6	RSM6BT	3,80
M8	21	2	RSM8AT	3,80
M10	30	2	RSM10T	6,80

RONDELLES EN NYLON / UNTERLEGSSCHEIBEN AUS NYLON



Mesure - Maß	ø est. ø ext.	épaisseur - Stärke in mm	Code - Code	€
M4	10	0,5	RPM4	0,30
M5	12	0,5	RPM5	0,30
M6	14	0,5	RPM6	0,30
M8	16	0,5	RPM8	0,30

## VIS DISQUE FREIN EN TITANE DÉGRÉ 5

170 SPEZIALSCHRAUBEN FÜR BREMSSCHEIBEN AUS TITAN HÄRTEGRAD 5

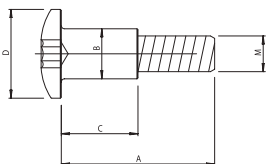

Les modèles de moto citées sont à titre indicatif. nous vous conseillons de vérifier la longueur des vis.

Bei bestellen bitte Motorrad Modell und Maße der standard Schraube genau angeben.

FINE DE LA SÉRIE - AUSLAUFARTIKEL

moto - Motorrad	M	A	B	C	D	Code - Code	€
							a pièce - 1 Stück
KAWASAKI	8	31	10	5	18	VIT K	19,70
SUZUKI	8	33	10	10	16	VIT S	18,60
SUZUKI	8	21	9,9	6	16	VIT S2	18,60
DUCATI	8	15	-	-	13	VIT D1	11,80
HONDA - Avant / Vorne	6	20	-	-	15	VIT H1	15,80
HONDA - Arrière / Hinten	8	23	10	5	16	VIT H2	15,80
HONDA CR. - Avant / Vorne	6	20	-	-	12	VIT H3	13,00
YAMAHA - Avant / Vorne	6	21	8	6	14	VIT Y	18,60
YAMAHA - Arrière / Hinten	8	20	9,8	4,5	16	VIT Y2	18,60

## RACCORD DE FREIN BREMSANSCHLÜSSE

FINE DE LA SÉRIE - AUSLAUFARTIKEL



Modèle - Modell	Mesure - Maß	Code - Code	€
Boulon simple Einzelschraube	M 10 X 1	VF11	5,30
	M 10 X 1,25	VF1251	5,30



Modèle - Modell	Mesure - Maß	Code - Code	€
Boulon double Doppelschraube	M 10 X 1	VF12	7,10
	M 10 X 1,25	VF1252	7,10



Modèle - Modell	Mesure - Maß	Code - Code	€
Boulon simple avec purge Einzelschraube mit Endlüfter	M 10 X 1	VF11SP	6,00
	M 10 X 1,25	VF1251SP	6,00



Modèle - Modell	Mesure - Maß	Code - Code	€
Boulon double avec purge Doppelschraube mit Endlüfter	M 10 X 1	VF12SP	7,90
	M 10 X 1,25	VF1252SP	7,90



Modèle - Modell	Mesure - Maß	Code - Code	€
Purge Endlüfter	M6	SPM6	3,60
	M7	SPM7	4,00
	M8	SPM8	4,20
	M 10 x 1	SPM10	5,40





**KITS VIS**  
SCHRAUBEN SET



Modèle Modell	MOTEUR / MOTOR				CADRE / RAHMEN			CARÉNAGE / VERKLEIDUNG		
	Année Jahr	Quantité Menge	Code Code	€	Quantité Menge	Code Code	€	Quantité Menge	Code Code	€

du - von    au - bis

APRILIA											
Dorsoduro 750	08	16	24	9AD M	46,30	29	9AD T	82,50	31	9AD C	87,00
Dorsoduro 1200	11	16	26	1AD M	70,30	25	1AD T	80,20	36	1AD C	103,50
RS 660	20	22	20	ENGAP001	53,60	9	FRMAP001	38,80	22	FARAP001	63,40
RSV 1000 R	05	08	56	5A1 M	133,50	33	5A1 T	101,00	67	5A1 C	149,90
RSV4 R / Factory / APRC / RF	09	20	30	9A4 M	76,80	22	9A4 T	75,10	44	9A4 C	108,30
Shiver	07	12	38	7A7 M	107,00	27	7A7 T	78,30	42	7A7 C	117,20
Tuono V4	11	20	34	1AT M	83,90	28	1AT T	100,30	42	1AT C	110,90

BMW											
S 1000 R	14	16	38	4BS M	106,90	25	4BS T	87,20	50	4BS C	135,20
S 1000 R	17	20	-	-	-	-	-	-	50	4BS C	135,20
S 1000 RR	09	14	38	0B1 M	106,90	23	0B1 T	58,60	66	0B1 C	154,30
S 1000 RR	15	18	34	5B1 M	95,40	19	5B1 T	66,70	63	5B1 C	225,30
S 1000 RR	19	22	19	9B1 M	54,10	14	9B1 T	58,00	23	9B1 C	74,40

CF MOTO											
NK 650	21	22	32	ENGCF001	88,70	12	FRMCF001	33,20	14	FARCF001	42,40

DUCATI											
848	08	12	24	8D8 M	49,70	16	8D8 T	44,00	77	8D8 C	201,70
1098 - 1198	07	11	26	7D1M	51,60	20	7D1 T	52,60	73	7D1 C	189,60
Diavel	11	16	35	2DD M	98,10	23	2DD T	77,10	42	2DD C	101,60
DS 1200 Multistrada	10	12	34	0D1 M	67,10	23	0D1 T	70,70	76	0D1 C	181,90
Hypermotard 1100	07	12	34	7DM M	67,00	24	7DM T	58,30	31	7DM C	90,70
Hypermotard 821 / Hyperstrada	13	15	44	3DH M	86,50	21	3DH T	73,90	54	3DH C	148,60
Monster 696	08	13	42	8D6 M	93,30	14	8D6 T	59,60	47	8D6 C	109,20
Monster 821	14	17	48	4D8 M	96,90	12	4D8 T	49,00	41	4D8 C	99,00
Monster 1100	11	13	39	1DM M	78,00	20	1DM T	66,40	38	1DM C	80,80
Monster 1200 / R	17	20	41	1D7 M	105,10	12	1D7 T	48,90	42	1D7 C	100,00
Panigale 1199 / 1199 R	12	14	24	2DP M	51,10	24	2DP T	73,30	62	2DP C	157,20
Panigale 1299 / 1299 R	15	17	16	6D1 M	41,90	20	6D1 T	64,40	73	6D1 C	179,40
Streetfighter 848	11	14	42	1D8 M	87,50	17	1D8 T	75,20	73	1D8 C	164,40
Streetfighter 1100	09	14	47	9DS M	93,90	13	9DS T	44,40	70	9DS C	155,10

HONDA											
CB500 F	13	15	34	3H5 M	93,30	21	3H5 T	77,10	41	3H5 C	115,80
CB650 F	14	17	25	4H6 M	69,90	39	4H6 T	125,90	36	4H6 C	102,50
CB 1000 R	08	17	25	8HB M	69,80	32	8HB T	110,10	31	8HB C	82,10
CB 1000 R	18	21	30	1H8 M	84,20	24	1H8 T	88,80	29	1H8 C	68,00
CBR 600 F	11	14	21	1H6 M	58,80	25	1H6 T	98,00	35	1H6 C	93,60
CBR 250 RR	11	14	24	2H5 M	67,60	20	2H5 T	61,30	34	2H5 C	89,30
CBR 600 RR	07	08	25	7H6 M	69,30	27	7H6 T	97,60	59	7H6 C	148,60
CBR 600 RR	09	12	-	-	-	30	9HC T	105,50	63	9HC C	160,30
CBR 600 RR	13	16	12	6H6 M	34,30	32	6H6 T	108,40	63	6H6 C	164,80
CBR 1000 RR	06	07	30	6H1 M	87,70	24	6H1 T	89,40	68	6H1 C	182,00
CBR 1000 RR	08	11	26	8H1 M	72,30	26	8H1 T	90,80	43	8H1 C	110,70
CBR 1000 RR	12	14	17	2HB M	48,90	27	2HB T	98,50	48	2HB C	129,60
CBR 1000 RR	17	19	24	1H7 M	67,10	28	1H7 T	106,70	36	1H7 C	92,10
CRF 450	08	09	37	8H4 M	103,50	17	8H4 T	41,40	27	8H4 C	71,80
CRF 450	10	11	39	0H4 M	110,50	6	0H4 T	18,50	38	0H4 C	101,00
Hornet 600	07	10	26	7HH M	72,40	27	7HH T	101,30	34	7HH C	97,20
Hornet 600	11	13	26	1HH M	72,40	25	1HH T	94,30	30	1HH C	78,30
Integra 700	12	13	-	-	-	11	2H1 T	52,30	29	2H1 C	76,20
NC 700 X	12	13	35	3H7 M	95,30	19	3H7 T	77,90	28	3H7 C	88,90
XADV 750	17	20	-	-	-	18	7H7 T	74,80	24	7H7 C	90,70

HUSQVARNA											
Nuda 900	12	14	45	1Q9 M	117,90	18	1Q9 T	66,60	37	1Q9 C	89,90



Modèle Modell	MOTEUR / MOTOR				CADRE / RAHMEN			CARÉNAGE / VERKLEIDUNG		
	Année Jahr	Quantité Menge	Code Code	€	Quantité Menge	Code Code	€	Quantité Menge	Code Code	€

du - von    au - bis

<b>KAWASAKI</b>											
ER-6N	09	11	33	9KR M	89,50	18	9KR T	59,90	40	9KR C	105,00
ER-6N	12	14	33	2KR M	89,50	14	2KR T	58,90	46	2KR C	109,00
Ninja 250R	09	12	12	9K2 M	32,90	19	9K2 T	93,70	52	9K2 C	127,90
*Ninja 300	13	17	26	3K3 M	71,70	27	3K3 T	115,70	45	3K3C	113,90
*Ninja 400	18	20	27	4K8 M	73,80	36	4K8 T	140,10	32	4K8 C	75,80
*Z 650	17	20	33	6K7 M	87,20	17	6K7 T	79,40	40	6K7 C	94,30
Z 650	21	22	32	ENGKA002	87,40	17	FRMKA002	78,30	42	FARKA002	99,60
Z 750	07	12	32	7K7 M	90,70	43	7K7 T	162,50	38	7K7 C	98,60
*Z 800	13	16	31	3K8 M	87,50	22	3K8 T	86,30	41	3K8 C	101,70
Z 900	17	20	25	9K7 M	70,10	19	9K7 T	72,60	24	9K7 C	62,40
Z1000	07	08	42	7K1 M	107,10	46	7K1 T	163,40	44	7K1 C	111,70
Z1000	09	09	42	9K1 M	107,10	45	9K1 T	165,10	50	9K1 C	126,50
Z1000	10	13	25	0KZ M	69,20	41	0KZ T	146,90	47	0KZ C	122,70
Z1000	14	14	26	4KZ M	72,60	31	4KZ T	122,80	54	4KZ C	124,10
Z1000 SX	11	13	21	1KS M	58,50	46	1KS T	160,10	50	1KS C	129,00
ZX6R	07	08	37	7K6 M	106,80	26	7K6 T	106,90	64	7K6 C	161,40
ZX6R	09	12	37	9K6 M	106,40	26	9K6 T	104,50	58	9K6 C	136,70
ZX6R	13	16	40	6K6 M	114,40	23	6K6 T	101,20	62	6K6 C	146,70
ZX10 R	04	05	32	4K1 M	85,50	28	4K1 T	113,20	58	4K1 C	140,10
ZX10 R	06	07	36	6K1 M	97,50	35	6K1 T	129,50	57	6K1 C	140,30
*ZX10 R	08	10	26	8K1 M	96,90	32	8K1 T	120,60	54	8K1 C	132,20
*ZX10 R	11	15	33	1K1 M	89,20	33	1K1 T	128,10	47	1K1 C	108,80
ZX10 R	16	20	25	1K6 M	66,00	25	1K6 T	106,80	56	1K6 C	135,80
ZX10 R	21	21	23	ENGKA001	63,50	10	ENGKA001	45,60	29	FARKA001	68,00

<b>KTM</b>											
Duke 125	17	19	31	8M1 M	85,50	23	8M1 T	78,10	31	8M1 C	85,50
Duke 690	07	10	28	7M6 M	77,80	23	7M6 T	63,30	26	7M6 C	73,00
Duke 690	12	14	27	2M6 M	75,80	22	2M6 T	71,10	43	2M6 C	88,00
Super Duke 990	07	10	29	7M9 M	85,10	30	7M9 T	82,00	21	7M9 C	37,90

<b>MV AGUSTA</b>											
Brutale 910	04	10	35	MV5 M	86,50	15	MV5 T	31,60	47	MV5 C	103,10
B3 675	12	16	30	4V6 M	72,30	20	4V6 T	55,80	37	4V6 C	79,50
B3 800	13	16	30	4V6 M	72,30	20	4V6 T	55,80	37	4V6 C	79,50
F3 675	12	14	20	MV3 M	52,70	23	MV3 T	63,30	59	MV3 C	143,20
F3 800	13	16	22	MV8 M	56,20	20	MV8 T	57,50	70	MV8 C	167,40
F4 1000	14	14	12	4V1 M	34,10	22	4V1 T	73,00	37	4V1 C	109,00
Rivale 800	14	17	28	5M8 M	73,10	26	5M8 T	55,70	73	5M8 C	172,20

<b>SUZUKI</b>											
Gladius	09	13	30	9SG M	88,20	20	9SG T	70,60	37	9SG C	110,10
GSR 600	06	11	39	6SR M	114,00	26	6SR T	86,40	28	6SR C	82,30
GSR 750	11	13	34	1SR M	98,40	27	1SR T	93,40	42	1SR C	124,40
GSXR 600/750	06	07	30	6S6 M	88,00	28	6S6 T	90,90	47	6S6 C	134,70
GSXR 600/750	08	10	33	8S6 M	94,60	26	8S6 T	81,30	48	8S6 C	130,10
GSXR 600/750	11	16	31	1SX M	90,80	38	1SXT	122,40	48	1SX C	141,00
GSXR 1000	05	06	38	5S1 M	105,40	38	5S1 T	140,10	46	5S1 C	137,60
GSXR 1000	07	08	32	7S1 M	92,40	39	7S1 T	127,10	48	7S1 C	153,80
GSXR 1000	09	16	25	9S1 M	70,40	22	9S1 T	79,60	49	9S1 C	154,20
GSXR 1000	17	22	25	1X7 M	70,10	29	1X7 T	85,00	33	1X7 C	92,40
GSX-S 750	17	21	31	7S7 M	92,90	20	7S7 T	77,00	31	7S7 C	91,40
GSX-S 1000	15	21	32	5SS M	94,70	26	5SS T	93,90	39	5SS C	119,10

# KITS VIS

## 174 SCHRAUBEN SETS

■ rouge Rot   
 ■ cobalt Kobalt   
 ■ noir Schwarz   
 ■ or Gold   
 ■ argent Silber   
 ■\* vert Grün   
 Only for some Kawasaki models NEW!

Modèle Modell	MOTEUR / MOTOR				CADRE / RAHMEN			CARÉNAGE / VERKLEIDUNG		
	Année Jahr	Quantité Menge	Code Code	€	Quantité Menge	Code Code	€	Quantité Menge	Code Code	€

du - von    au - bis

TRIUMPH											
Daytona 675	07	12	33	7TD M	87,60	34	7TD T	112,30	46	7TD C	117,70
Speed Triple 1050	11	15	52	0TT M	139,90	33	0TT T	151,10	48	0TT C	135,60
Speed Triple 1050	16	16	57	6T1 M	151,10	24	6T1 T	75,70	47	6T1 C	111,00
Speed Triple RS 1200	21	22	38	ENGTR002	102,00	6	FRMTR002	18,60	13	FARTR002	31,60
Speed Triple 675 / 675R	07	12	36	7T6 M	95,10	29	7T6 T	98,70	33	7T6 C	93,30
Speed Triple 675 / 675R	13	16	38	3T6 M	100,00	33	3T6 T	109,00	40	3T6 C	104,70
Speed Triple 765 / 765 R	17	21	39	7T7M	103,60	28	7T7T	93,20	34	7T7C	80,10
Trident 660	21	22		ENGTR001	xxx		FRMTR001	xxx		FARTR001	xxx

YAMAHA											
Fazer 600 / FZ6 600	04	12	40	4Y6 M	79,60	24	4Y6 T	87,90	38	4Y6 C	95,60
FZ1	06	15	35	6Y1 M	88,60	22	6Y1 T	81,60	58	6Y1 C	151,00
FZ8	10	15	28	0Y8 M	71,10	28	0Y8 T	94,80	51	0Y8 C	126,10
MT-03	06	13	30	6YM M	73,90	25	6YM T	86,90	44	6YM C	108,50
MT-07	14	20	31	4Y7 M	82,50	22	4Y7 T	81,50	51	4Y7 C	124,20
MT-09	13	16	40	3YM M	106,70	18	3YM T	67,00	44	3YM C	102,30
MT-09 Tracer	15	16	41	5Y9 M	112,50	27	5Y9 T	95,80	50	5Y9 C	171,20
MT-09	17	20	39	9Y7 M	106,30	18	9Y7 T	80,60	33	9Y7 C	98,10
MT-09	21	21	34	ENGYA001	95,10	19	FRMYA001	85,20	15	FARYA001	49,10
MT-10	16	20	32	6Y0 M	86,60	27	6Y0 T	96,10	42	6Y0 C	99,10
R1	04	06	26	4Y1 M	52,90	28	4Y1 T	107,00	62	4Y1 C	167,30
R1	07	08	33	7Y1 M	67,10	33	7Y1 T	117,70	52	7Y1 C	138,60
R1	09	14	33	9Y1 M	86,70	23	9Y1 T	78,00	52	9Y1 C	136,80
R1 / R1M	15	19	28	5Y1 M	75,50	27	5Y1 T	89,00	53	5Y1 C	136,10
R1 / R1M	20	20	28	5Y1 M	75,50	27	5Y1 T	89,00	32	0Y1 C	81,60
R3	15	17	27	5Y3 M	71,70	23	5Y3 T	90,20	45	5Y3 C	105,90
R6	06	07	32	6Y6 M	62,60	28	6Y6 T	104,10	60	6Y6 C	159,80
R6	08	16	32	8Y6 M	62,60	22	8Y6 T	89,40	54	8Y6 C	141,80
R6	17	20	29	6Y7 M	78,40	16	6Y7 T	58,50	31	6Y7 C	83,90
R7	22	22	28	ENGYA002	75,40	15	FRMYA002	37,70	31	FARYA002	102,20
T Max 500	08	11	17	8YT M	48,50	-	-	-	43	8YT C	124,30
T Max 530	12	16	-	-	-	16	2YXT	51,60	34	2YX C	93,90
XJ6	08	13	28	8YJ M	74,60	18	8YJ T	70,20	48	8YJ C	120,00
X-Max 400	13	14	15	3YX M	38,30	-	-	-	39	3YX C	118,70







**ÉCROUX  
SPECIAUX  
SPEZIALMUTTERN**

# ÉCROUX SPECIAUX EN ERGAL 7075

176 SPEZIALMUTTERN AUS ERGAL 7075

Nm = Couple de serrage maximale / Nm: maximale Drehmoment



**D001**  
M 25 X 1,5    30  
Ø 39 · h 13    Nm 350



**D002**  
M 25 X 1    32  
ø 39,5 · h 14    Nm 300



**D003**  
M 24 X 1,5    32  
ø 39 · h 17,5    Nm 330



**D004**  
M 18 X 1,5    22  
ø 29 · h 14    Nm 140



**D005**  
M 22 x 1    32  
ø 39,5 · h 16,5    Nm 250



**D006**  
M 24 x 1    30  
ø 37 · h 16,5    Nm 300



**D007**  
M 14 x 1,5    22  
ø 29,5 · h 13    Nm 67



**D008**  
38 x 1,5    46  
ø 63,5 · h 28,5    Nm 1240



**D009**  
33 x 1,5    41  
ø 49,5 · h 14    Nm 900



**D010**  
20 x 1,5    27  
ø 34,8 · h 15    Nm 200

## POSITION - POSITION

- 1 Axe de roue avant / Vordere Radmutter
- 2 Colonne de direction / Lenkermutter
- 3 Axe de bras oscillant / Radmutter
- 4 Axe de roue arrière / Hintere radmutter

<span style="color: red;">■</span> rouge Rot	<span style="color: blue;">■</span> cobalt Kobalt	<span style="color: black;">■</span> noir Schwarz	<span style="color: gold;">■</span> or Gold	<span style="color: silver;">■</span> argent Silber
---	--	--	--	--



Modèle - Modell	Année - Jahr		1		2		3		4	
	du - von	au - bis	Code-Code	€	Code-Code	€	Code-Code	€	Code-Code	€
<b>APRILIA</b>										
Dorsoduro 750	08	13	D001	21,40	-	-	D010	21,40	D001	21,40
Dorsoduro 1200	11	13	D001	21,40	-	-	D010	21,40	D001	21,40
RSV 1000	04	05	D001	21,40	-	-	D010	21,40	D001	21,40
RSV4 / Factory / APRC	09	20	D001	21,40	-	-	D010	21,40	D001	21,40
Shiver 750	07	13	D001	21,40	-	-	D010	21,40	D001	21,40
Tuono	06	09	-	-	-	-	D010	21,40	D001	21,40
Tuono V4	11	20	D001	21,40	-	-	D010	21,40	D001	21,40
<b>BMW</b>										
F800R	10	10	-	-	-	-	-	-	D011	21,40
S1000R	14	22	-	-	-	-	D004	22,10	D003	23,80
S1000RR	09	22	-	-	D014	23,20	D004	22,10	D003	23,80



**D011**  
16 x 1,5 22  
ø 25,8 · h 14,5 Nm 100



**D013**  
24 x 1,5 32  
ø 39,8 · h 14,5 Nm 330



**D014**  
28 x 1 34  
ø 42,3 · h 19,7 Nm 520



**D018**  
22 x 1,5 32  
ø 38,4 · h 19,5 Nm 270



**D019**  
25 x 1,25 28  
ø 33,3 · h 10 Nm 250



**D020**  
38 x 1,5 46  
ø 55 · h 19 Nm 1240



**D021**  
35 x 1,5 46  
ø 55 · h 18 Nm 960



**D022**  
33 x 1 41  
ø 46 · h 16 Nm 850



**D023**  
35 x 1,5 46  
ø 55 · h 21 Nm 970

Modèle - Modell	Année - Jahr	1	2	3	4
-----------------	--------------	---	---	---	---

	du - von	au - bis	Code-Code	€	Code-Code	€	Code-Code	€	Code-Code	€
<b>DUCATI</b>										
748 / 916 / 996 / 998	96	01	D019	22,70	-	-	-	-	D008 (right side)	59,50
									D009 (left side)	41,70
848	08	11	-	-	-	-	-	-	D020 (right side)	53,60
									D009 (left side)	41,70
Hypermotard 821	13	14	-	-	-	-	-	-	D020 (right side)	53,60
									D009 (left side)	41,70
Hypermotard 1100	07	12	D019	22,70	-	-	-	-	D008 (right side)	59,50
									D009 (left side)	41,70
Monster / 610 ie	03	07	D019	22,70	-	-	-	-		-

<b>HONDA</b>										
CB 500 F	13	13	-	-	-	-	-	-	D011	21,40
CB 650 F	14	15	-	-	-	-	D004	22,10	D004	22,40
CB 1000 R	08	17	-	-	D006	21,40	D004	22,10	D023	41,70
CBR 250 RR	11	12	-	-	-	-	-	-	D011	21,40
CBR 600 F	11	13	-	-	D006	21,40	D004	22,10	D004	22,10
CBR 600 RR	05	06	-	-	D006	21,40	-	-	D018	22,00
CBR 600 RR	07	16	-	-	D006	21,40	D004	22,10	D018	22,00
CBR 1000 RR	04	07	-	-	-	-	D018	23,80	D018	22,00
CBR 1000 RR	08	16	-	-	D022	27,30	D018	23,80	D018	22,00
CBR 1000RR-R / SP	20	22	-	-	-	-	-	-	D003	23,80
Hornet 600	03	06	-	-	D006	21,40	D007	21,40	D011	21,40
Hornet 600	07	13	-	-	D006	21,40	D004	22,10	D004	22,10
Hornet 900	02	08	-	-	D006	21,40	-	-	D004	22,10
Integra	12	14	-	-	-	-	-	-	D004	22,10
NC700X	12	14	-	-	-	-	-	-	D004	22,10
XADV	17	22	-	-	-	-	-	-	D004	22,10

<b>HUSQVARNA</b>										
Nuda 900	12	15	-	-	-	-	D007	21,40	D011	21,40

# ÉCROUX SPECIAUX EN ERGAL 7075

178 SPEZIALMUTTERN AUS ERGAL 7075

Modèle - Modell		Année - Jahr		1	2	3	4			
du - von	au - bis	Code-Code	€	Code-Code	€	Code-Code	€	Code-Code	€	
<b>KAWASAKI</b>										
Ninja 250 R	09	12	D007	21,40	-	-	-	D011	21,4	
Ninja 300 R	13	16	-	-	-	-	-	-	-	
ZX6R	03	04	-	-	D002	21,40	D010	21,4	D003	23,8
ER-6N	06	08	-	-	-	-	-	D004	22,4	
ER-6N	09	11	-	-	-	-	D010	21,4	D004	22,4
ER-6N	12	13	-	-	-	-	-	D004	22,4	
Z 650	17	22	-	-	-	-	-	D004	22,4	
Z 750	07	12	-	-	-	-	D010	21,4	D004	22,4
Z 800	12	16	-	-	-	-	-	D004	22,4	
Z 900	17	21	-	-	-	-	-	D004	22,4	
Z 1000	03	06	-	-	-	-	D010	21,4	D003	23,8
Z 1000	07	09	-	-	-	-	D010	21,4	D003	23,8
Z 1000 / Z1000 SX	10	16	-	-	-	-	D010	21,4	-	-
ZX6R / 636	06	21	-	-	D014	23,20	D010	21,4	D003	23,8
ZX10 R	04	05	-	-	D014	23,20	D010	21,4	D004	22,4
ZX10 R	06	07	-	-	D014	23,20	D010	21,4	D004	22,4
ZX10 R	08	10	-	-	-	-	D010	21,4	D004	22,4
ZX10 R	11	22	-	-	D014	23,20	D010	21,4	D003	23,8
<b>MV</b>										
B3 675 / B3 800	12	17	D019	22,70	-	-	-	-	-	-
F3 675 / F3 800	12	17	D019	22,70	-	-	-	-	-	-
Rivale 800	14	17	D019	22,70	-	-	-	-	-	-
<b>SUZUKI</b>										
Gladius	09	13	-	-	D005	21,40	-	-	D010	21,40
GSR 600	06	11	-	-	D013	21,40	D010	21,40	D018	23,80
GSR 750	11	16	-	-	-	-	-	-	D018	23,80
GSXR 1000	05	16	-	-	D014	23,20	D010	21,40	D001	21,40
GSXR 600 / 750	06	10	-	-	D014	23,20	D010	21,40	D001	21,40
GSXR 600 / 750	11	17	D010	21,40	D014	23,20	D010	21,40	D018	23,80
GSXS 1000 / GSXS 1000F	15	19	D010	21,40	-	23,20	D010	21,40	D001	21,40
SV 650 / 650S	03	08	-	-	D013	21,40	D004	22,40	D004	22,40
<b>TRIUMPH</b>										
Daytona 675 / 675R	07	16	-	-	D002	21,40	D011	21,40	D004	22,40
Speed Triple 1050 / 1050R	08	16	-	-	-	-	-	-	D020 (right side)	53,60
									D021 (left side)	41,70
Street Triple 675 / 675R	07	16	-	-	D002	21,40	D011	21,40	D004	22,40
Street Triple 765 R / S / RS	17	21	-	-	D002	21,40	D011	21,40	D004	22,40
<b>YAMAHA</b>										
MT-03 (660cc) monocilindrico	06	14	-	-	D005	21,40	D011	21,40	D011	21,40
MT-03 (321cc) bicilindrico	16	18	-	-	-	-	-	-	D011	21,40
MT-07	13	20	-	-	-	-	-	-	D004	22,1
MT-09 / MT-09 Tracer	13	20	-	-	-	-	-	-	D004	22,1
MT-09	21	22	-	-	-	-	-	-	D003	23,8
MT10	16	21	-	-	-	-	-	-	D003	23,8
Fazer 600 / FZ6	04	12	-	-	D005	21,40	D004	22,1	D003	23,8
FZ8	10	16	-	-	D014	23,20	D004	22,1	D003	23,8
FZ1 / Fazer 1000	06	12	-	-	D014	23,20	D004	22,1	D003	23,8
R1	04	06	-	-	D014	23,20	D004	22,1	D003	23,8
R1	07	14	-	-	D014	23,20	D010	21,40	D003	23,8
R1 / R1M	15	21	-	-	-	-	-	-	D003	23,8
R3	15	21	-	-	-	-	-	-	D011	21,40
R6	06	22	-	-	D014	23,20	D018	23,8	D003	23,8
R7	22	22	-	-	-	-	-	-	D003	23,8
T-Max 530 / 560	12	21	-	-	-	-	-	-	D013	21,40
XJ6	08	12	-	-	D005	21,40	D007	21,40	D011	21,40



**BOUCHONS**  
TANKDECKEL







## BOUCHONS DE RÉSERVOIR



182 TANKDECKEL

FINE DE LA SÉRIE - AUSLAUFARTIKEL

■ rouge  
■ Rot  
■ cobalt  
■ Kobalt  
■ noir  
■ Schwarz  
■ or  
■ Gold  
■ argent  
■ Silber

































ATTACHE RAPIDE  
SCHNELLVERSCHLUSS

À VIS  
GEWINDEVERSCHLUSS

Modèle - Modell	Année - Jahr		Code - Code	€	Code - Code	€
						
<b>APRILIA</b>						
RS 660	20	22	TR14 ■■	122,50	TF14 ■■	95,00
RSV 1000	04	08	TR10 ■■	141,90	-	
RSV4 R / Factory / APRC	09	22	TR10 ■■	141,90	-	
Tuono 660	20	22	TR14 ■■	122,50	TF14 ■■	95,00
Tuono V4	11	22	TR10 ■■	141,90	-	
<b>BMW</b>						
S 1000 R	14	19	TR11 ■■	141,90	-	
S 1000 RR	09	21	TR11 ■■	141,90	-	
<b>DUCATI</b>						
Diavel	11	17	-		TF13 ■■	95,00
Monster 821	14	17	TR26 ■■	123,70	-	
Monster 1200 / R	17	20	TR26 ■■	123,70	-	
Streetfighter 848 / 1100	09	16	TR10 ■■	141,90	-	
<b>GUZZI</b>						
Universal (modello con 6 fori - Ø 99,5 mm)	-	-	TR5 ■■	122,50	TF5 ■■	84,00
<b>HONDA</b>						
CB 125 R	18	20	TR24 ■■	141,90	TF24 ■■	95,00
CB 300 R	18	19	TR24 ■■	141,90	TF24 ■■	95,00
CB 500 R	16	20	TR24 ■■	141,90	TF24 ■■	95,00
CB 650 R	18	20	TR24 ■■	141,90	TF24 ■■	95,00
CB 650 R	21	22	TR27 ■■	141,90	-	
CB 1000 R	18	20	TR24 ■■	141,90	TF24 ■■	95,00
CBR 600 RR	13	16	TR22 ■■	141,90	TF22 ■■	95,00
CBR 1000 RR	04	11	TR22 ■■	141,90	TF22 ■■	95,00
CBR 1000 RR	12	14	TR18 ■■	141,90	TF18 ■■	95,00
CBR 1000 RR	15	16	TR22 ■■	141,90	TF22 ■■	95,00
CBR 1000 RR	17	19	TR24 ■■	141,90	TF24 ■■	95,00
CBR 1000 RR-R / SP	20	22	TR27 ■■	141,90	-	
<b>KAWASAKI</b>						
Ninja 300	13	17	TR21 ■■	122,50	TF21 ■■	84,00
Ninja 400	18	21	TR23 ■■	141,90	-	
Z 650	17	22	TR23 ■■	141,90	-	
Z 900	17	22	TR23 ■■	141,90	-	
ZX636	19	20	TR23 ■■	141,90	-	
ZX 10 R	21	22	TR23 ■■	141,90	-	
<b>KTM</b>						
Duke 790	18	21	TR25 ■	122,50	TF25 ■	95,00
<b>MV AGUSTA</b>						
Brutale B3 675 / 800	12	17	TR16 ■■	128,20	TF16 ■■	95,00
F3 675 / 800	12	17	TR16 ■■	128,20	TF16 ■■	95,00
Rivale	14	17	TR16 ■■	128,20	TF16 ■■	95,00



FINE DE LA SÉRIE - AUSLAUFARTIKEL

Modèle - Modell	Année - Jahr	ATTACHE RAPIDE SCHNELLVERSCHLUSS			À VIS GEWINDEVERSCHLUSS		
		Code - Code	€		Code - Code	€	
							
<b>SUZUKI</b>							
GSR 600	06 11	TR20	122,50		TF20	95,00	
GSR 750	11 16	TR20	122,50		TF20	95,00	
GSXR 600 / 750	04 17	TR20	122,50		TF20	95,00	
GSXR 1000	03 16	TR20	122,50		TF20	95,00	
GSXR 1000	17 22	TR20	122,50		TF20	95,00	
GSXS 750	17 21	TR20	122,50		TF20	95,00	
GSXS 1000	15 21	TR20	122,50		TF20	95,00	
<b>TRIUMPH</b>							
Daytona 675 / 675 R / 765	11 20	TR14	122,50		TF14	95,00	
Speed Triple 1050	11 18	TR14	122,50		TF14	95,00	
Street Triple 675 / 675 R	11 16	TR14	122,50		TF14	95,00	
Street Triple 765 S / 765 R / RS	17 22	TR14	122,50		TF14	95,00	
<b>YAMAHA</b>							
MT-07	14 22	TR26	123,70		-		
MT-09 / SP / MT-09 Tracer	13 22	TR26	123,70		-		
MT-10	16 21	TR26	123,70		-		
R1 / R1M	04 22	TR26	123,70		-		
R3	15 22	TR26	123,70		-		
R6	08 22	TR26	123,70		-		
R7	22 22	TR26	123,70		-		
XSR 700	17 20	TR26	123,70		-		



# BOUCHONS DE RÉSERVOIR

184 TANKDECKEL

NEW!



Model FCF

Réchange bride interne - Ersatzteil Schnellverschluss

FCF € 32,10

Couleur disponible - Verfügbare Farben:



a pièce - 1 Stück



Model TRF

Réchange bride interne - Ersatzteil Schnellverschluss

TRF € 61,80

Couleur disponible: noir  
Verfügbare Farben: Schwarz

a pièce - 1 Stück



Model TFC

Réchange bride interne - Ersatzteil Schnellverschluss

TFC € 29,80

Couleur disponible: noir  
Verfügbare Farben: Schwarz

a pièce - 1 Stück



Clé universale pour bouchon réservoir et bouchon d'huile  
Universeller racing Schlüssel für Tankdeckel und Öldeckel

TFT € 32,10

a pièce - 1 Stück



- rouge  
Rot
- cobalt  
Kobalt
- noir  
Schwarz
- or  
Gold
- argent  
Silber
- vert  
Grün

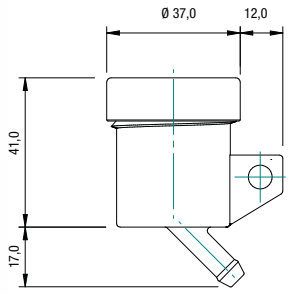

cm<sup>3</sup> 16

Réservoir (maitre cylindre) transparent fumé avec bouchon en aluminium  
Ölbehälter durchsichtig, leicht getönt, mit Deckel aus Aluminium

OBT004 € 43,50  
a pièce - 1 Stück



NEW!

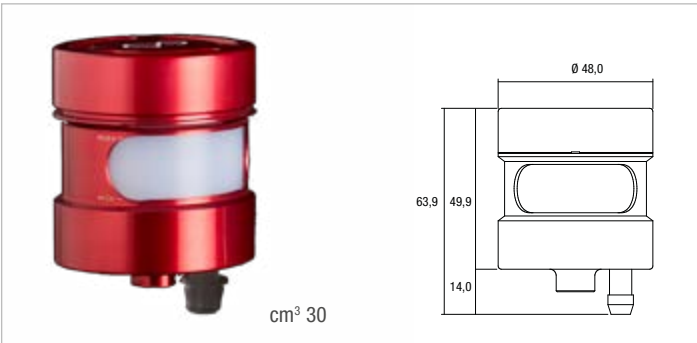

Réservoir (maitre cylindre) en aluminium  
Ölbehälter mit Schale aus Aluminium

OBT005 € 53,60  
a pièce - 1 Stück



Réservoir (maitre cylindre) en aluminium  
Ölbehälter mit Schale aus Aluminium

OBT002 € 65,40  
a pièce - 1 Stück



noir  
Schwarz

assembled on: OBT001



noir  
Schwarz

assembled on: OBT002

Support pour OBT001 / OBT002 / Support für OBT001 / OBT002

OBT003 € 36,80  
a pièce - 1 Stück

# BOUCHONS D'HUILE

186 ÖLVERSCHLUSSSCHRAUBE



Modèle - Modell	Année - Jahr		Filetage - Gewinde	Code - Code	€	Code - Code	€
-----------------	--------------	--	--------------------	-------------	---	-------------	---

APRILIA							
Dorsoduro 750	08	13	M 25 X 1,5	OIL 002	24,20	OILA	24,20
Dorsoduro 750	14	16	M 20 X 1,5	OIL 001	24,20	OILS	22,90
Dorsoduro 900	18	21	M 20 X 1,5	OIL 001	24,20	OILS	22,90
Dorsoduro 1200	11	16	M 20 X 1,5	OIL 001	24,20	OILS	22,90
RSV 4 (all versions)	09	22	M 25 X 1,5	OIL 002	24,20	OILA	24,20
RS 660	20	22	M 20 X 1,5	OIL 001	24,20	OILS	22,90
Shiver 750	07	15	M 25 X 1,5	OIL 002	24,20	OILA	24,20
Tuono	06	09	M 20 X 1,5	OIL 001	24,20	OILS	22,90
Tuono V4	11	22	M 25 X 1,5	OIL 002	24,20	OILA	24,20

BMW							
R Nine-T / Scrambler / Pure / Urban / Racer	16	19	M 34 x 1,5	OIL 008	26,80	-	
R 1200 GS	08	12	M 34 x 1,5	OIL 008	26,80	-	
S1000 R	14	22	M 24 X 2	OIL 007	24,20	OILBM01	24,20
S1000 RR	09	22	M 24 X 2	OIL 007	24,20	OILBM01	24,20

DUCATI							
848	08	10	M 20 X 2,5	OIL 011	24,20	-	
1098 - 1198	07	11	M 22 X 1,5	OIL 003	22,90	OILD	22,90
Hypermotard 796	09	12	M 20 X 2,5	OIL 011	24,20	-	
Hypermotard 821 / hyperstrada 821	13	15	M 20 X 2,5	OIL 011	24,20	-	
Hypermotard 939	16	18	M 20 X 2,5	OIL 011	24,20	-	
Hypermotard 950	19	22	M 20 X 2,5	OIL 011	24,20	-	
Monster 696	08	15	M 19,5 X 2,5	OIL 004	22,90	OILH	22,90
Monster 821	14	19	M 20 X 2,5	OIL 011	24,20	-	
Monster 1100	11	13	M 20 X 2,5	OIL 011	24,20	-	
Monster 1200 / 1200S	14	20	M 20 X 2,5	OIL 011	24,20	-	
Multistrada 1200	10	13	M 19,5 X 2,5	OIL 004	22,90	OILH	22,90
Multistrada V4 / S	21	22	M 19,5 X 2,5	OIL 004	22,90	OILH	22,90
Panigale 1199 / 899	12	15	M 19,5 X 2,5	OIL 004	22,90	OILH	22,90
Panigale V2 / 955	20	22	M 19,5 X 2,5	OIL 004	22,90	OILH	22,90
Panigale1299 / V4	15	22	M 20 X 2,5	OIL 011	24,20	-	
Streetfighter 848	11	16	M 20 X 2,5	OIL 011	24,20	-	
Streetfighter 1100	09	15	M 22 X 1,5	OIL 003	22,90	OILD	22,90
Streetfighter V2 / S	22	22	M 19,5 X 2,5	OIL 004	22,90	OILH	22,90
Streetfighter V4 / S	20	22	M 20 X 2,5	OIL 011	24,20	-	

GUZZI							
Griso 850 / 1100 / 1150	06	15	M 20 X 1,5	OIL 001	24,20	OILS	22,90

HONDA							
tous / alle	-	-	M 19,5 X 2,5	OIL 004	22,90	OILH	22,90
CB 500 R	16	21	M 19,5 X 2,5	OIL 004	22,90	OILH	22,90
CB 650 R	19	22	M 20 X 2,5	OIL 011	24,20	-	
CBR 1000 RR-R / SP	20	22	M 20 X 2,5	OIL 011	24,20	-	
XADV	17	22	M 20 X 2,5	OIL 011	24,20	-	



Only: OIL004 / OIL005 / OIL011      Only: OIL013



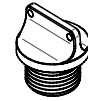

Modèle - Modell	Année - Jahr		Filetage - Gewinde	Code - Code	€	Code - Code	€
<b>KAWASAKI</b>							
* ER 6N	06	15	M 19,5 X 2,5	OIL 004	<b>22,90</b>	OILH	<b>22,90</b>
* Ninja 400	18	22	M 20 X 2,5	OIL 011	<b>24,20</b>	-	
* Z125	19	20	M 20 X 2,5	OIL 011	<b>24,20</b>	-	
* Z400	17	22	M 20 X 2,5	OIL 011	<b>24,20</b>	-	
* Z 650	17	22	M 20 X 2,5	OIL 011	<b>24,20</b>	-	
* Z 800	13	16	M 20 X 2,5	OIL 011	<b>24,20</b>	-	
* Z 900	17	22	M 20 X 2,5	OIL 011	<b>24,20</b>	-	
* Z 1000	03	09	M 30 X 1,5	OIL 005	<b>26,80</b>	OILK2	<b>24,40</b>
* Z 1000	10	19	M 20 X 2,5	OIL 011	<b>24,20</b>	-	
* Z 1000 SX	11	19	M 20 X 2,5	OIL 011	<b>24,20</b>	-	
* ZX6R / 636	05	21	M 30 X 1,5	OIL 005	<b>26,80</b>	OILK2	<b>24,40</b>
* ZX10R	04	22	M 30 X 1,5	OIL 005	<b>26,80</b>	OILK2	<b>24,40</b>
<b>KTM</b>							
Duke 790	18	21	M 24 X 3	OIL 013	<b>22,90</b>	-	
Duke 890 R	20	22	M 24 X 3	OIL 013	<b>22,90</b>	-	
Duke 1290 R	20	22	M 24 X 3	OIL 013	<b>22,90</b>	-	
<b>MV AGUSTA</b>							
Brutale 750 / 910 / 990 / 1090	00	17	M 25 X 1,5	OIL 002	<b>24,20</b>	-	
B3 675 / 800	12	17	M 24 X 3	OIL 013	<b>22,90</b>	-	
F3 675 / 800	12	17	M 24 X 3	OIL 013	<b>22,90</b>	-	
F4 750 / 910 / 990 / 1090	00	17	M 25 X 1,5	OIL 002	<b>24,20</b>	-	
Rivale 800	13	17	M 24 X 3	OIL 013	<b>22,90</b>	-	
<b>SUZUKI</b>							
GSXR 600 / 750	06	10	M 20 X 1,5	OIL 001	<b>24,20</b>	OILS	<b>22,90</b>
GSXR 600 / 750	11	17	M 20 X 1,5	OIL 001	<b>24,20</b>	OILS	<b>22,90</b>
GSXR 1000	07	11	M 20 X 1,5	OIL 001	<b>24,20</b>	OILS	<b>22,90</b>
GSXR 1000	12	16	M 20 X 1,5	OIL 001	<b>24,20</b>	OILS	<b>22,90</b>
GSXR 1000	17	22	M 20 X 1,5	OIL 001	<b>24,20</b>	OILS	<b>22,90</b>
GSX-S 750	17	21	M 20 X 1,5	OIL 001	<b>24,20</b>	OILS	<b>22,90</b>
GSX-S 1000	15	22	M 20 X 1,5	OIL 001	<b>24,20</b>	OILS	<b>22,90</b>
<b>TRIUMPH</b>							
tous / alle	-	-	M 19,5 X 2,5	OIL 004	<b>22,90</b>	OILH	<b>22,90</b>
Street Triple 765S / 765R / 765RS	17	22	M 20 X 2,5	OIL 011	<b>24,20</b>	-	
<b>YAMAHA</b>							
MT-03 (660CC) monocilindrico	06	14	M 19,5 X 2,5	OIL 004	<b>22,90</b>	OILH	<b>22,90</b>
MT-03 (321CC) bicilindrico	16	22	M 26 X 3	OIL 006	<b>24,20</b>	OILY	<b>24,20</b>
MT-07 / XMT-07	14	22	M 26 X 3	OIL 006	<b>24,20</b>	OILY	<b>24,20</b>
MT-09 / SP / MT-09 Tracer	13	22	M 20 X 2,5	OIL 011	<b>24,20</b>	-	
MT-10	16	21	M 26 X 3	OIL 006	<b>24,20</b>	OILY	<b>24,20</b>
R1 / R1M	15	22	M 26 X 3	OIL 006	<b>24,20</b>	OILY	<b>24,20</b>
R3	15	22	M 26 X 3	OIL 006	<b>24,20</b>	OILY	<b>24,20</b>
R6	06	22	M 26 X 3	OIL 006	<b>24,20</b>	OILY	<b>24,20</b>
R7	22	22	M 26 X 3	OIL 006	<b>24,20</b>	OILY	<b>24,20</b>
T-Max 500 / 530 / 560	08	22	M 19,5 X 2,5	OIL 004	<b>22,90</b>	OILH	<b>22,90</b>

# CACHE BOCAL LIQUIDE DE FREIN ET EMBRAYAGE



Modèle - Modell	Année - Jahr		Article - Artikel	Codce - Code	€	
	du - von	au - bis				
<b>APRILIA</b>						
Dorsoduro 750	09	16	frein antérieur / vordere Bremse	■ ■	FBC17	33,20
			frein postérieur / hintere Bremse	■ ■ ■ ■ ■	FFC05	24,40
			embrayage / Kupplung	■ ■	FFC06	33,20
Dorsoduro 900	18	20	frein antérieur / vordere Bremse	■ ■	FBC17	33,20
			frein postérieur / hintere Bremse	■ ■ ■ ■ ■	FFC05	24,40
			embrayage / Kupplung	■ ■	FFC06	33,20
RSV 4 (all versions)	09	22	frein antérieur / vordere Bremse	■ ■ ■ ■ ■ ■ ■	FBC04	25,50
RS 660 / Tuono 660	21	22	frein antérieur / vordere Bremse	■ ■ ■ ■ ■ ■ ■	FBC04	25,50
Shiver 750	07	16	frein postérieur / hintere Bremse	■ ■ ■ ■ ■	FFC05	24,40
Tuono V4	11	22	frein antérieur / vordere Bremse	■ ■ ■ ■ ■ ■ ■	FBC04	25,50
<b>BMW</b>						
R Nine-T / Scrambler / Pure / Urban / Racer	16	19	frein antérieur / vordere Bremse	■ ■	FBC25	53,60
			embrayage / Kupplung	■ ■	FFC11	53,60
S 1000 R	14	22	frein antérieur / vordere Bremse	■ ■ ■ ■ ■ ■ ■	FBC06	25,50
S 1000 RR	09	22	frein antérieur / vordere Bremse	■ ■ ■ ■ ■ ■ ■	FBC06	25,50
<b>DUCATI</b>						
848 / 1098 / 1198	07	11	frein antérieur / vordere Bremse	■ ■ ■ ■ ■ ■ ■	FBC04	25,50
			frein postérieur / hintere Bremse	■ ■	FFC03	22,00
			embrayage / Kupplung	■ ■	FFC03	22,00
Hypermotard 821 / 939	12	17	frein antérieur / vordere Bremse	■ ■	FBC07	33,20
			frein postérieur / hintere Bremse	■ ■	FFC03	22,00
Hypermotard 950 / SP	19	22	frein antérieur / vordere Bremse	■ ■ ■ ■ ■ ■ ■	FBC04	25,50
			frein postérieur / hintere Bremse	■ ■	FFC03	22,00
			embrayage / Kupplung	■ ■ ■ ■ ■ ■ ■	FBC27	22,00
Hypermotard 1100	07	10	frein antérieur / vordere Bremse	■ ■ ■ ■ ■ ■ ■	FBC04	25,50
			frein postérieur / hintere Bremse	■ ■	FFC03	22,00
			embrayage / Kupplung	■ ■	FFC03	22,00
Monster 696 / 796	08	15	frein antérieur / vordere Bremse	■ ■	FBC07	33,20
			frein postérieur / hintere Bremse	■ ■	FFC03	22,00
			embrayage / Kupplung	■ ■	FFC04	30,90
Monster 821	14	17	frein antérieur / vordere Bremse	■ ■	FBC07	33,20
			frein postérieur / hintere Bremse	■ ■	FFC03	22,00
Monster 1100	11	13	frein postérieur / hintere Bremse	■ ■	FFC03	22,00
Monster 1200 / 1200S	14	21	frein antérieur / vordere Bremse	■ ■ ■ ■ ■ ■ ■	FBC04	25,50
			frein postérieur / hintere Bremse	■ ■	FFC03	22,00
			embrayage / Kupplung	■ ■ ■ ■ ■ ■ ■	FBC27	22,00
Multistrada 1200	10	12	frein antérieur / vordere Bremse	■ ■ ■ ■ ■ ■ ■	FBC04	25,50
			frein postérieur / hintere Bremse	■ ■	FFC03	22,00
			embrayage / Kupplung	■ ■	FFC03	22,00
Panigale 959	16	20	frein antérieur / vordere Bremse	■ ■ ■ ■ ■ ■ ■	FBC04	25,50
			frein postérieur / hintere Bremse	■ ■	FFC03	22,00
			embrayage / Kupplung	■ ■	FFC03	22,00
Panigale V2 955	21	22	frein antérieur / vordere Bremse	■ ■ ■ ■ ■ ■ ■	FBC04	25,50
			frein postérieur / hintere Bremse	■ ■	FFC03	22,00
			embrayage / Kupplung	■ ■ ■ ■ ■ ■ ■	FBC27	22,00
Panigale 1199 / 1299	12	17	frein antérieur / vordere Bremse	■ ■ ■ ■ ■ ■ ■	FBC04	25,50
			frein postérieur / hintere Bremse	■ ■	FFC03	22,00
			embrayage / Kupplung	■ ■	FFC03	22,00
Panigale V4 / S / R	18	19	frein antérieur / vordere Bremse	■ ■ ■ ■ ■ ■ ■	FBC04	25,50
			frein postérieur / hintere Bremse	■ ■	FFC03	22,00
			embrayage / Kupplung	■ ■ ■ ■ ■ ■ ■	FBC27	22,00
Panigale V4 / S / R	20	22	frein antérieur / vordere Bremse	■ ■ ■ ■ ■ ■ ■	FBC04	25,50
			frein postérieur / hintere Bremse	■ ■ ■ ■ ■ ■ ■	FBC27	22,00
			embrayage / Kupplung	■ ■ ■ ■ ■ ■ ■	FBC27	22,00
Streetfighter 848 / 1100	09	16	frein antérieur / vordere Bremse	■ ■	FBC18	33,20
			frein postérieur / hintere Bremse	■ ■	FFC03	22,00
			embrayage / Kupplung	■ ■	FFC07	33,20



FBC21



FFC06



FBC19



FBC18

Modèle - Modell	Année - Jahr		Article - Artikel	Codce - Code	€	
	du - von	au - bis				
<b>DUCATI</b>						
Streetfighter V2 / S	22	22	frein antérieur / vordere Bremse		FBC04	25,50
			frein postérieur / hintere Bremse		FBC27	22,00
			embrayage / Kupplung		FBC27	22,00
Streetfighter V4 / S	21	22	frein antérieur / vordere Bremse		FBC04	25,50
			frein postérieur / hintere Bremse		FBC27	22,00
			embrayage / Kupplung		FBC27	22,00
<b>HONDA</b>						
CB 125 R	18	22	frein postérieur / hintere Bremse		FBC28	25,50
CB 650F	14	15	frein antérieur / vordere Bremse		FBC01	35,70
CB 650R	19	22	frein antérieur / vordere Bremse		FBC01	35,70
CB 1000 R	08	17	frein antérieur / vordere Bremse		FBC06	25,50
			frein postérieur / hintere Bremse		FBC06	25,50
			embrayage / Kupplung		FFC05	24,40
CB 1000 R	18	22	frein antérieur / vordere Bremse		FBC29	40,10
			frein postérieur / hintere Bremse		FBC28	25,50
CBR 500 R	16	20	frein postérieur / hintere Bremse		FBC28	25,50
CBR 600 RR	03	06	frein antérieur / vordere Bremse		FBC01	35,70
CBR 600 RR	07	16	frein antérieur / vordere Bremse		FBC06	25,50
CBR 1000 RR	08	17	frein antérieur / vordere Bremse		FBC06	25,50
			frein droit / rechte Bremse		FFC05	24,40
CBR 1000 RR-R	20	22	frein antérieur / vordere Bremse		FBC06	25,50
CBR 1000 RR-R SP	20	22	frein antérieur / vordere Bremse		FBC04	25,50
Hornet 600	11	13	frein antérieur / vordere Bremse		FBC01	35,70
XADV	17	22	frein droit / rechte Bremse		FBC01	35,70
			frein gauche / linke Bremse		FBC01	35,70
<b>HUSQVARNA</b>						
900 NUDA	12	15	frein antérieur / vordere Bremse		FBC04*	25,5

\* nécessaire deux vis 005-M5x45 / erfordert zwei Schrauben 005-M5x45





Modèle - Modell	Année - Jahr		Article - Artikel	Codce - Code	€
	du - von	au - bis			
<b>KAWASAKI</b>					
ER-6N	06	08	frein antérieur / vordere Bremse		FBC02 33,20
ER-6N	09	15	frein antérieur / vordere Bremse		FBC16 25,50
Ninja 250 R	09	12	frein postérieur / hintere Bremse		FBC06 25,50
Ninja 250 / 400	18	21	frein antérieur / vordere Bremse		FBC26 33,20
			frein postérieur / hintere Bremse		FFC05 24,40
Ninja 650	21	22	frein antérieur / vordere Bremse		FBC16 25,50
Z650	17	22	frein antérieur / vordere Bremse		FBC16 25,50
Z750 / Z1000	03	06	frein antérieur / vordere Bremse		FBC02 33,20
Z750	07	12	frein antérieur / vordere Bremse		FBC06 25,50
Z750 R	11	12	frein antérieur / vordere Bremse		FBC19 33,20
Z800	13	16	frein antérieur / vordere Bremse		FBC16 25,50
			frein postérieur / hintere Bremse		FFC05 24,40
Z900	17	22	frein antérieur / vordere Bremse		FBC16 25,50
Z1000	07	09	frein antérieur / vordere Bremse		FBC06 25,50
	10	18	frein antérieur / vordere Bremse		FBC19 33,20
Z1000SX	11	20	frein antérieur / vordere Bremse		FBC06 25,50
			frein postérieur / hintere Bremse		FFC05 24,40
ZX6R	07	08	frein antérieur / vordere Bremse		FBC06 25,50
			frein postérieur / hintere Bremse		FFC05 24,40
ZX6R	09	15	frein antérieur / vordere Bremse		FBC06 25,50
			frein postérieur / hintere Bremse		FBC23 24,40
ZX6R	16	21	frein antérieur / vordere Bremse		FBC06 25,50
			frein postérieur / hintere Bremse		FFC05 24,40
ZX10R	08	15	frein antérieur / vordere Bremse		FBC06 25,50
			frein postérieur / hintere Bremse		FFC05 24,40
ZX10R	16	20	frein antérieur / vordere Bremse		FBC04 25,50
			frein postérieur / hintere Bremse		FFC05 24,40
ZX10R	21	22	frein antérieur / vordere Bremse		FBC04 25,50
			frein postérieur / hintere Bremse		FBC32 25,50
<b>KTM</b>					
Duke 790	18	22	frein antérieur / vordere Bremse		FBC30 44,10
Duke 890 R	21	22	frein antérieur / vordere Bremse		FBC30 44,10
RC8 1190	08	12	frein antérieur / vordere Bremse		FBC06 25,50
990 Super Duke	07	12	frein antérieur / vordere Bremse		FBC04 25,50
			frein postérieur / hintere Bremse		FFC03 22,00
690 SM / SMR	07	12	frein antérieur / vordere Bremse		FFC04 30,90
			frein postérieur / hintere Bremse		FFC03 22,00
1290 Super Duke R	20	22	frein antérieur / vordere Bremse		FBC04 25,50
			embrayage / Kupplung		FBC31 24,40
<b>MV AGUSTA</b>					
B3 675 / 800	12	17	frein antérieur / vordere Bremse		FBC03 35,70
Dragster	15	17	frein antérieur / vordere Bremse		FBC03 35,70
F3 675 / 800	12	17	frein antérieur / vordere Bremse		FBC06 25,50
Brutale	05	17	frein antérieur / vordere Bremse		FBC03 35,70
			embrayage / Kupplung		FFC01 35,70
F4	00	09	frein antérieur / vordere Bremse		FBC03 35,70
			embrayage / Kupplung		FFC01 35,70
F4	14	17	frein antérieur / vordere Bremse		FBC04 25,50
			embrayage / Kupplung		FFC03 22,00
Rivale 800	14	17	frein antérieur / vordere Bremse		FBC03 35,70



FBC17



FBC06



FFC03



FBC07



FBC27



Modèle - Modell	Année - Jahr		Article - Artikel	Codce - Code	€
	du - von	au - bis			
<b>SUZUKI</b>					
Gladius 650	09	15	frein antérieur / vordere Bremse		FBC13 33,20
GSR 600	06	12	frein antérieur / vordere Bremse		FBC13 33,20
GSR 750	11	16	frein antérieur / vordere Bremse		FBC13 33,20
GSXR 600 / 750	04	10	frein antérieur / vordere Bremse		FBC06 25,50
GSXR 1000	05	06	frein antérieur / vordere Bremse		FBC06 25,50
GSXR 1000	07	08	frein antérieur / vordere Bremse		FBC06 25,50
			embrayage / Kupplung		FFC05 24,40
GSXR 1000	09	22	frein antérieur / vordere Bremse		FBC06 25,50
GSX-S 750	17	21	frein antérieur / vordere Bremse		FBC13 33,20
GSX-S 1000	15	22	frein antérieur / vordere Bremse		FBC24 25,50
Katana	19	22	frein antérieur / vordere Bremse		FBC24 25,50
<b>TRIUMPH</b>					
Daytona 675 / 675 R	07	16	frein antérieur / vordere Bremse		FBC06 25,5
			frein postérieur / hintere Bremse		FFC05 24,4
Speed Triple 1050	12	18	frein antérieur / vordere Bremse		FBC04 25,5
			frein postérieur / hintere Bremse		FFC05 24,4
Speed Triple RS 1200	21	22	frein antérieur / vordere Bremse		FBC04 25,5
Street Triple 675 / 675 R	07	16	frein postérieur / hintere Bremse		FFC05 24,4
Street Triple 765S / 765R / 765RS	17	22	frein antérieur / vordere Bremse		FBC04 25,5
			frein postérieur / hintere Bremse		FFC05 24,4
<b>YAMAHA</b>					
Fazer 1000	01	05	frein antérieur / vordere Bremse		FBC02 33,20
FZ1	06	15	frein antérieur / vordere Bremse		FBC11 35,70
FZ8	10	15	frein antérieur / vordere Bremse		FBC11 35,70
FZ6	04	06	frein antérieur / vordere Bremse		FBC11 35,70
MT-03	06	13	frein antérieur / vordere Bremse		FBC11 35,70
			frein postérieur / hintere Bremse		FFC05 24,40
MT-07 / Tracer	14	22	frein antérieur / vordere Bremse		FBC02 33,20
			frein postérieur / hintere Bremse		FFC05 24,40
MT-09 / Tracer	13	20	frein antérieur / vordere Bremse		FBC11 35,70
			frein postérieur / hintere Bremse		FFC05 24,40
MT-09 / SP	21	22	frein antérieur / vordere Bremse		FBC06 25,50
			frein postérieur / hintere Bremse		FFC05 24,40
R1	04	22	frein antérieur / vordere Bremse		FBC06 25,50
R1 / R1M	15	22	frein postérieur / hintere Bremse		FBC23 24,40
R6	03	05	frein antérieur / vordere Bremse		FBC06 25,50
R6	06	22	frein antérieur / vordere Bremse		FBC06 25,50
			frein postérieur / hintere Bremse		FFC05 24,40
R7	22	22	frein antérieur / vordere Bremse		FBC06 25,50
			frein postérieur / hintere Bremse		FFC05 24,40
T - MAX 500 / 530 / 560	04	22	frein antérieur / vordere Bremse		FBC15 33,20
			frein postérieur / hintere Bremse		FBC15 33,20
XJ6	08	15	frein antérieur / vordere Bremse		FBC11 35,70



FBC01



FBC02



FBC04



FBC11



FBC18



FBC25



FBC26



FBC29



Lightech  
made in Italy





**CARBONE**  
CARBONTEILE

NEW!

Modèle - Modell	Année - Jahr		Code - Code	€	Code - Code	€
	du - von	au - bis	BRILLANTE-GLÄNZEND		OPAQUE-MATT	
<b>RS660 / TUONO 660</b>						
garde boue avant / Vordere Kotflügel	20	22	CARA0610	<b>288,00</b>		
couvre chaîne / Kette Abdeckung	20	22	CARA0612	<b>201,60</b>		
garde boue arrière / Hintere Kotflügel	20	22	CARA0620	<b>206,40</b>		
protection de réservoir / Tankdeckel	20	22	CARA0629	<b>211,20</b>		
protection cadre / Rahmen Abdeckung	20	22	CARA0650	<b>304,80</b>		
protection bras oscillant / Schwingen Abdeckung	20	22	CARA0660	<b>290,40</b>		
couvre de siège passager / Beifahrersitzbezug	20	22	CARA0690	<b>206,40</b>		
protection de réservoir / Tankschutz	20	22	CARA0685	<b>151,20</b>		

<b>RSV4 (all models)</b>						
garde boue avant / Vordere Kotflügel	09	14	CARA3010	<b>190,80</b>		
garde boue arrière / Hintere Kotflügel	09	14	CARA3020	<b>146,40</b>		
protection carter embrayage / Kupplungs - Deckel	09	14	CARA3030	<b>137,40</b>		
protection carter alternateur / Lichtmaschine Deckel	09	14	CARA3040	<b>112,80</b>		
protection cadre / Rahmen Abdeckung	09	14	CARA3050	<b>220,80</b>		
protection bras oscillant / Schwingen Abdeckung	09	14	CARA3060	<b>206,40</b>		
tubes air box / Airbox Rohre	09	14	CARA3019	<b>316,80</b>		
couvre chaîne / Kette Abdeckung	09	14	CARA3012	<b>89,00</b>		
couvre chaîne inférieur / Untere Kette Abdeckung	09	14	CARA3013	<b>81,40</b>		
panneaux sous réservoir / Tankschutz (unten)	09	14	CARA3080	<b>314,40</b>		

<b>RSV4 (all models)</b>						
garde boue avant / Vordere Kotflügel	15	20	CARA3010	<b>190,80</b>		
garde boue arrière / Hintere Kotflügel	15	20	CARA3020	<b>146,40</b>		
protection carter embrayage / Kupplungs - Deckel	15	20	CARA3030	<b>137,40</b>		
protection carter alternateur / Lichtmaschine Deckel	15	20	CARA3040	<b>112,80</b>		
protection cadre / Rahmen Abdeckung	15	20	CARA4050	<b>229,00</b>		
protection bras oscillant / Schwingen Abdeckung	15	20	CARA4060	<b>206,40</b>		
tubes air box / Airbox Rohre	15	20	CARA3019	<b>316,80</b>		
couvre chaîne / Kette Abdeckung	15	20	CARA3012	<b>89,00</b>		
couvre chaîne inférieur / Untere Kette Abdeckung	15	20	CARA3013	<b>81,40</b>		
panneaux sous réservoir / Tankschutz (unten)	15	20	CARA3080	<b>314,40</b>		





Modèle - Modell	Année - Jahr		Code - Code	€	Code - Code		€
	du - von	au - bis			BRILLANTE-GLÄNZEND	OPAQUE-MATT	
<b>RSV4 1100 Factory</b>							
garde boue avant / Vordere kotflügel	21	22	CARA0610	<b>288,00</b>			
garde boue arrière / Hintere kotflügel	21	22	CARA2020	<b>211,20</b>			
protection carter embrayage / Kupplungs - Deckel	21	22	CARA3030	<b>137,40</b>			
protection carter alternateur / Lichtmaschine Deckel	21	22		<b>xxx</b>			
protection cadre / Rahmen Abdeckung	21	22	CARA4050	<b>229,00</b>			
protection bras oscillant / Schwingen Abdeckung	21	22	CARA2060	<b>319,20</b>			
couvre chaîne / Kette Abdeckung	21	22	CARA2012	<b>146,40</b>			
protection de réservoir / Tankschutz	21	22	CARA2090	<b>151,20</b>			
panneaux sous réservoir / Tankschutz (unten)	21	22	CARA2080	<b>324,00</b>			

<b>TUONO V4</b>							
garde boue avant / Vordere kotflügel	11	20	CARA3010	<b>189,60</b>			
garde boue arrière / Hintere kotflügel	11	20	CARA3020	<b>146,40</b>			
protection carter embrayage / Kupplungs - Deckel	11	20	CARA3030	<b>137,40</b>			
protection carter alternateur / Lichtmaschine Deckel	11	20	CARA3040	<b>112,80</b>			
protection bras oscillant / Schwingen Abdeckung	11	20	CARA3060	<b>206,40</b>			
couvre chaîne / Kette Abdeckung	11	20	CARA3012	<b>89,00</b>			
panneaux sous réservoir / Tankschutz (unten)	11	20	CARA3013	<b>81,40</b>			

<b>TUONO V4 Factory</b>							
garde boue avant / Vordere kotflügel	21	22	CARA0610	<b>288,00</b>			
garde boue arrière / Hintere kotflügel	21	22	CARA2020	<b>211,20</b>			
protection carter embrayage / Kupplungs - Deckel	21	22	CARA3030	<b>137,40</b>			
protection cadre / Rahmen Abdeckung	21	22	CARA4050	<b>229,00</b>			
protection bras oscillant / Schwingen Abdeckung	21	22	CARA2060	<b>319,20</b>			
couvre chaîne / Kette Abdeckung	21	22	CARA2012	<b>146,40</b>			
protection de réservoir / Tankschutz	21	22	CARA2090	<b>151,20</b>			
panneaux sous réservoir / Tankschutz (unten)	21	22	CARA2080	<b>324,00</b>			



CARA2080

Modèle - Modell	Année - Jahr		Code - Code	€	Code - Code	€
	du - von	au - bis	BRILLANTE-GLÄNZEND		OPAQUE-MATT	
<b>R-NINE T Scrambler</b>						
garde boue avant (installation latéral) / Vordere Kotflügel (seitliche Befestigung)	14	19	CARB2000	<b>276,00</b>	CARB2000M	<b>276,00</b>
garde boue avant (installation par-dessus) / Vordere Kotflügel (obere Befestigung)	14	19	CARB2010	<b>228,00</b>	CARB2010M	<b>228,00</b>
protection moteur / Motorschutz	17	20	CARB2210	<b>228,00</b>	CARB2210M	<b>228,00</b>

<b>S 1000 R</b>						
garde boue avant / Vordere kotflügel	13	19	CARB1010	<b>190,80</b>		
garde boue arrière / Hintere kotflügel	13	19	CARB1020	<b>173,00</b>		
protection carter embrayage / Kupplungs - Deckel	13	14	CARB1030	<b>137,40</b>		
protection carter embrayage / Kupplungs - Deckel	15	18	CARB1031	<b>137,40</b>		
protection carter altermateur / Lichtmaschine Deckel	13	19	CARB1040	<b>114,50</b>		
couvre pick up / pick up Deckel	13	16	CARB1018	<b>86,50</b>		
protection cadre / Rahmen Abdeckung	13	16	CARB1050	<b>216,20</b>		
protection cadre / Rahmen Abdeckung	17	19	CARB1051	<b>216,20</b>		
protection bras oscillant / Schwingen Abdeckung	13	16	CARB1060	<b>203,50</b>		
protection bras oscillant / Schwingen Abdeckung	17	19	CARB1061	<b>216,20</b>		

**BMW**

<b>S 1000 RR</b>						
garde boue avant / Vordere kotflügel	09	18	CARB1010	<b>190,80</b>		
garde boue arrière / Hintere kotflügel	09	18	CARB1020	<b>173,00</b>		
protection carter embrayage / Kupplungs - Deckel	09	14	CARB1030	<b>137,40</b>		
protection carter embrayage / Kupplungs - Deckel	15	18	CARB1031	<b>137,40</b>		
protection carter altermateur / Lichtmaschine Deckel	09	18	CARB1040	<b>114,50</b>		
couvre pick up / pick up Deckel	09	16	CARB1018	<b>86,50</b>		
protection cadre / Rahmen Abdeckung	09	14	CARB1050	<b>216,20</b>		
protection cadre / Rahmen Abdeckung	15	18	CARB1051	<b>216,20</b>		
protection bras oscillant / Schwingen Abdeckung	09	14	CARB1060	<b>203,50</b>		
protection bras oscillant / Schwingen Abdeckung	15	18	CARB1061	<b>216,20</b>		
tubes air box / Airbox Rohre	09	11	CARB1019	<b>151,20</b>		

<b>S 1000 RR</b>						
garde boue avant / Vordere kotflügel	19	22	CARB1910	<b>300,00</b>		
garde boue arrière avec couvre chaîne / Hintere kotflügel mitKette Abdeckung	19	22	CARB1920	<b>326,40</b>		
couvre pick up / pick up Deckel	19	22	CARB1918	<b>134,40</b>		
protection carter embrayage / Kupplungs - Deckel	19	22	CARB1930	<b>139,90</b>		
protection carter altermateur / Lichtmaschine Deckel	19	22	CARB1940	<b>122,40</b>		
protection cadre / Rahmen Abdeckung	19	22	CARB1950	<b>357,60</b>		
protection bras oscillant / Schwingen Abdeckung	19	22	CARB1960	<b>326,40</b>		
protection de réservoir / Tankdeckel	19	22	CARB1929	<b>314,40</b>		



FINE DE LA SÉRIE - AUSLAUFARTIKEL

Modèle - Modell	Année - Jahr		Code - Code	€	Code - Code	€
	du - von	au - bis	BRILLANTE-GLÄNZEND		OPAQUE-MATT	
<b>HYPERMOTARD 950</b>						
couvre chaîne / Kette Abdeckung	19	21	CARD0412	<b>105,60</b>		
garde boue arrière / Hintere kotflügel	19	21	CARD0420	<b>204,00</b>		
protection bras oscillant / Schwingen Abdeckung	19	21	CARD0460	<b>211,20</b>		
protection de réservoir / Tankdeckel	19	21	CARD0429	<b>300,00</b>		
couvre latéraux pour échappement / Seitenabdeckungen für Auspuff	19	21	CARD0402	<b>348,00</b>		
protection latéral pour radiateur / Seitenabdeckung für Kühler	19	21	CARD0425	<b>297,60</b>		
<b>PANIGALE 899</b>						
garde boue avant / Vordere kotflügel	13	15	<b>CARD1010</b>	<b>292,80</b>		
protection carter alternateur / Lichtmaschine Deckel	13	15	<b>CARD1040</b>	<b>152,60</b>		
protection suspension arrière / Zentralfederschutz (hinten)	13	15	<b>CARD1039</b>	<b>96,00</b>		
<b>PANIGALE 1199 / 1299</b>						
garde boue avant / Vordere kotflügel	12	17	<b>CARD1010</b>	<b>292,80</b>		
garde boue arrière / Hintere kotflügel	12	17	<b>CARD1020</b>	<b>240,00</b>		
protection carter embrayage / Kupplungs - Deckel	12	17	<b>CARD1030</b>	<b>127,20</b>		
protection carter alternateur / Lichtmaschine Deckel	12	17	<b>CARD1040</b>	<b>152,60</b>		
protection bras oscillant / Schwingen Abdeckung	12	17	<b>CARD1060</b>	<b>232,80</b>		
couvre chaîne / Kette Abdeckung	12	17	<b>CARD1012</b>	<b>96,00</b>		
protection suspension arrière / Zentralfederschutz (hinten)	12	17	<b>CARD1039</b>	<b>96,00</b>		
<b>PANIGALE V4</b>						
protèges de talon en carbon / Carbon Fersenschutz	18	21	CARD0801	<b>144,00</b>	CARD0801M	<b>144,00</b>
garde boue avant / Vordere kotflügel	18	21	CARD0810	<b>300,00</b>	CARD0810M	<b>300,00</b>
garde boue arrière / Hintere kotflügel	18	21	CARD0820	<b>302,40</b>	CARD0820M	<b>302,40</b>
protection carter embrayage / Kupplungs - Deckel	18	21	CARD0830	<b>144,00</b>	CARD0830M	<b>144,00</b>
protection carter alternateur / Lichtmaschine Deckel	18	21	CARD0840	<b>144,00</b>	CARD0840M	<b>144,00</b>
couvre têtes G+D / Kopfbedeckung L+R	18	21	CARD0841	<b>316,80</b>	CARD0841M	<b>316,80</b>
protection cadre / Rahmen Abdeckung	18	21	CARD0850	<b>288,00</b>	CARD0850M	<b>288,00</b>
protection bras oscillant / Schwingen Abdeckung	18	21	CARD0860	<b>287,50</b>	CARD0860M	<b>287,50</b>
Alu -Slider pour la protection du bras oscillant en Carbon / Alu -Slider für die Schwingen Carbon Abdeckung	18	21	CARD0861-01sil	<b>xxx</b>		<b>xxx</b>
couverture totale du réservoir / gesamte Tankabdeckung	18	21	CARD0827	<b>451,200</b>	CARD0827M	<b>451,20</b>
protection de réservoir avec couvre de clé intégré / Tankdeckel mit integriertem Schlüsseldeckel	18	21	CARD0828	<b>338,40</b>	CARD0828M	<b>338,40</b>
protection de réservoir / Tankdeckel	18	21	CARD0829	<b>216,00</b>	CARD0829M	<b>216,00</b>
panneaux sous réservoir / Tankschutz (unten)	18	21	CARD0880	<b>254,40</b>	CARD0880M	<b>254,40</b>
queue / Das Eck	18	21	CARD0890	<b>422,40</b>	CARD0890M	<b>422,40</b>
défecteurs latéraux / Seitliche Entlüfter	18	21	CARD0815	<b>672,00</b>	CARD0815M	<b>672,00</b>



PANIGALE V4  
CARD0827



PANIGALE V4  
CARD0841



FINE DE LA SÉRIE - AUSLAUFARTIKEL

Modèle - Modell	Année - Jahr		Code - Code	€	Code - Code	€
	du - von	au - bis	BRILLANTE-GLÄNZEND		OPAQUE-MATT	
<b>STREETFIGHTER V4</b>						
protèges de talon en carbon / Carbon Fersenschutz	20	21	CARD0801	<b>144,00</b>	CARD0801M	<b>144,00</b>
garde boue avant / Vordere kotflügel	20	21	CARD0810	<b>300,00</b>	CARD0810M	<b>300,00</b>
garde boue arrière / Hintere kotflügel	20	21	CARD0820	<b>302,40</b>	CARD0820M	<b>302,40</b>
protection carter embrayage / Kupplungs - Deckel	20	21	CARD0730	<b>147,60</b>	CARD0730M	<b>147,60</b>
protection carter alternateur / Lichtmaschine Deckel	20	21	CARD0840	<b>144,00</b>	CARD0840M	<b>144,00</b>
couvre têtes G+D / Kopfbedeckung L+R	20	21	CARD0841	<b>316,80</b>	CARD0841M	<b>316,80</b>
protection cadre / Rahmen Abdeckung	20	21	CARD0750	<b>288,00</b>	CARD0750M	<b>288,00</b>
protection bras oscillant / Schwingen Abdeckung	20	21	CARD0760	<b>287,30</b>	CARD0760M	<b>287,30</b>
protection de réservoir / Tankdeckel	20	21	CARD0729	<b>225,60</b>	CARD0729M	<b>225,60</b>
queue / Das Eck	20	21	CARD0890	<b>422,40</b>	CARD0890M	<b>422,40</b>
panneaux sous réservoir / Tankschutz (unten)	20	21	CARD0780	<b>374,40</b>	CARD0780M	<b>374,40</b>
protection latérale supérieure pour radiateur / Obere Seitenabdeckung für Kühler	20	21	CARD0725	<b>244,80</b>	CARD0725M	<b>244,80</b>
protection latérale inférieure pour radiateur / Untere Seitenabdeckung für Kühler	20	21	CARD0726	<b>220,80</b>	CARD0726M	<b>220,80</b>
soportes relojes / Instrumenten Halterung	20	21	CARD0770	<b>192,00</b>	CARD0770M	<b>192,00</b>

DUCATI





FINE DE LA SÉRIE - AUSLAUFARTIKEL

Modèle - Modell	Année - Jahr		Code - Code	€	Code - Code		€
	du - von	au - bis	BRILLANTE-GLÄNZEND		OPAQUE-MATT		
<b>CB 1000 R</b>							
garde boue avant / Vordere kotflügel	18	20	CARH7710	<b>283,20</b>			
couvre chaîne / Kette Abdeckung	18	20	CARH7712	<b>105,60</b>			
protection couronne / Rad Protektor	18	20	CARH7713	<b>81,60</b>			
garde boue arrière / Hintere kotflügel	18	20	CARH7720	<b>190,80</b>			
protection carter embrayage / Kupplungs - Deckel	18	20	CARH7730	<b>137,40</b>			
protection carter alternateur / Lichtmaschine Deckel	18	20	CARH7740	<b>114,50</b>			
protection bras oscillant / Schwingen Abdeckung	18	20	CARH7760	<b>120,00</b>			
support compteur / Instrumenten Halterung	18	20	CARH7770	<b>100,80</b>			
<b>CBR 600 RR</b>							
garde boue avant / Vordere kotflügel	07	16	<b>CARH6510</b>	<b>190,80</b>			
garde boue arrière / Hintere kotflügel	07	16	<b>CARH8920</b>	<b>144,00</b>			
protection carter embrayage / Kupplungs - Deckel	07	16	<b>CARH6530</b>	<b>137,40</b>			
protection carter alternateur / Lichtmaschine Deckel	07	16	<b>CARH6540</b>	<b>101,80</b>			
protection cadre / Rahmen Abdeckung	07	16	<b>CARH6550</b>	<b>216,20</b>			
protection bras oscillant / Schwingen Abdeckung	07	16	<b>CARH6560</b>	<b>190,80</b>			
<b>CBR 1000 RR</b>							
garde boue avant / Vordere kotflügel	08	16	CARH1710	<b>283,20</b>			
couvre chaîne / Kette Abdeckung	08	16	CARH1712	<b>124,80</b>			
garde boue arrière / Hintere kotflügel	08	11	CARH7620	<b>175,20</b>			
garde boue arrière / Hintere kotflügel	12	16	CARH1720	<b>175,20</b>			
protection carter alternateur / Lichtmaschine Deckel	08	16	CARH7640	<b>114,50</b>			
protection carter embrayage / Kupplungs - Deckel	08	16	CARH7630	<b>137,40</b>			
protection cadre / Rahmen Abdeckung	08	16	CARH7650	<b>220,80</b>			
protection bras oscillant / Schwingen Abdeckung	08	16	CARH7660	<b>196,80</b>			
<b>CBR 1000 RR</b>							
garde boue avant / Vordere kotflügel	17	19	CARH1710	<b>283,20</b>			
couvre chaîne / Kette Abdeckung	17	19	CARH1712	<b>124,80</b>			
garde boue arrière / Hintere kotflügel	17	19	CARH1720	<b>175,20</b>			
protection carter embrayage / Kupplungs - Deckel	17	19	CARH1730	<b>137,40</b>			
protection carter alternateur / Lichtmaschine Deckel	17	19	CARH1740	<b>114,50</b>			
protection cadre / Rahmen Abdeckung	17	19	CARH1750	<b>228,00</b>			
protection bras oscillant / Schwingen Abdeckung	17	19	CARH1760	<b>206,40</b>			
<b>CBR 1000 RR-R</b>							
garde boue avant / Vordere kotflügel	20	22	CARH2110	<b>288,00</b>			
garde boue arrière / Hintere kotflügel	20	22	CARH2120	<b>235,20</b>			
couvre pick up / pick up Deckel	20	22	CARH2118	<b>100,80</b>			
protection carter embrayage / Kupplungs - Deckel	20	22	CARH2130	<b>136,80</b>			
protection carter alternateur / Lichtmaschine Deckel	20	22	CARH2140	<b>112,80</b>			
protection cadre / Rahmen Abdeckung	20	22	CARH2150	<b>240,00</b>			
protection bras oscillant / Schwingen Abdeckung	20	22	CARH2160	<b>216,20</b>			

HONDA



HONDA CB 1000 R  
CARH7710



HONDA CB 1000 R  
CARH7720

Modèle - Modell	Année - Jahr		Code - Code	€	Code - Code		€
	du - von	au - bis	BRILLANTE-GLÄNZEND		OPAQUE-MATT		
<b>ZX6R / 636</b>							
garde boue avant / Vordere kotflügel	09	18	CARK9610	<b>190,80</b>			
garde boue arrière / Hintere kotflügel	09	21	CARK9520	<b>152,60</b>			
protection carter embrayage / Kupplungs - Deckel	09	21	CARK9530	<b>120,00</b>			
protection carter alternateur / Lichtmaschine Deckel	09	21	CARK9540	<b>101,80</b>			
couvre pick up / pick up Deckel	09	21	CARK9518	<b>120,00</b>			
protection cadre / Rahmen Abdeckung	09	21	CARK9550	<b>203,50</b>			
protection bras oscillant / Schwingen Abdeckung	09	21	CARK9560	<b>190,80</b>			
couvre chaîne / Kette Abdeckung	09	21	CARK9512	<b>114,50</b>			
<b>ZX10R</b>							
garde boue avant / Vordere kotflügel	11	15	CARK9610	<b>190,80</b>			
garde boue arrière / Hintere kotflügel	11	15	CARK9620	<b>152,60</b>			
couvre chaîne / Kette Abdeckung	11	15	CARK9612	<b>114,50</b>			
protection carter embrayage / Kupplungs - Deckel	11	15	CARK9630	<b>124,80</b>			
protection carter alternateur / Lichtmaschine Deckel	11	15	CARK9640	<b>114,50</b>			
couvre pick up / pick up Deckel	11	15	CARK9618	<b>114,50</b>			
protection cadre / Rahmen Abdeckung	11	15	CARK9650	<b>220,80</b>			
protection bras oscillant / Schwingen Abdeckung	11	15	CARK9660	<b>196,80</b>			
<b>ZX10R</b>							
garde boue avant / Vordere kotflügel	16	22	CARK9810	<b>300,00</b>			
garde boue arrière / Hintere kotflügel	11	22	CARK9620	<b>152,60</b>			
couvre chaîne / Kette Abdeckung	11	22	CARK9612	<b>114,50</b>			
protection carter embrayage / Kupplungs - Deckel	11	22	CARK9630	<b>124,80</b>			
protection carter alternateur / Lichtmaschine Deckel	11	22	CARK9640	<b>114,50</b>			
couvre pick up / pick up Deckel	11	22	CARK9618	<b>114,50</b>			
protection cadre / Rahmen Abdeckung	16	22	CARK9850	<b>228,00</b>			
protection bras oscillant / Schwingen Abdeckung	16	22	CARK9860	<b>206,40</b>			
<b>Z900</b>							
garde boue avant / Vordere kotflügel	17	22	CARK8010	<b>288,00</b>			
garde boue arrière / Hintere kotflügel	17	22	CARK8020	<b>290,40</b>			
protection carter embrayage / Kupplungs - Deckel	17	22	CARK8030	<b>132,30</b>			
protection carter alternateur / Lichtmaschine Deckel	17	22	CARK8040	<b>114,50</b>			
couvre pick up / pick up Deckel	17	22	CARK8018	<b>96,70</b>			
support compteur / Instrumenten Halterung	17	20	CARK8070	<b>132,00</b>			
support compteur / Instrumenten Halterung	21	22	CARK8071	<b>132,00</b>			

KAWASAKI



KAWASAKI Z900  
CARK8010



KAWASAKI Z900  
CARK8020



KAWASAKI Z900  
CARK8070

FINE DE LA SÉRIE - AUSLAUFARTIKEL

Modèle - Modell	Année - Jahr		Code - Code		€	Code - Code		€
	du - von	au - bis	BRILLANTE-GLÄNZEND			OPAQUE-MATT		
<b>B3 / F3 / RIVALE</b>								
garde boue avant / Vordere kotflügel	12	19	CARM1010		300,00	CARM1010M		300,00
garde boue arrière / Hintere kotflügel	12	19	CARM1020		182,40	CARM1020M		182,40
couvre chaîne / Kette Abdeckung	12	19	CARM1012		96,00	CARM1012M		96,00





FINE DE LA SÉRIE - AUSLAUFARTIKEL

Modèle - Modell	Année - Jahr		Code - Code	€	Code - Code		€
	du - von	au - bis	BRILLANTE-GLÄNZEND		OPAQUE-MATT		
<b>GSX-R 600 / 750</b>							
garde boue avant / Vordere kotflügel	11	17	CARS6110	190,80			
garde boue arrière / Hintere kotflügel	11	17	CARS6120	157,70			
protection carter embrayage / Kupplungs - Deckel	11	17	CARS8030	124,80			
protection carter alternateur / Lichtmaschine Deckel	11	17	CARS6040	120,00			
protection cadre / Rahmen Abdeckung	11	17	CARS6150	220,80			
protection bras oscillant / Schwingen Abdeckung	11	17	CARS6160	196,80			
<b>GSX-R 1000</b>							
garde boue avant / Vordere kotflügel	09	16	CARS6410	190,80			
garde boue arrière / Hintere kotflügel	09	16	CARS6420	157,70			
protection carter embrayage / Kupplungs - Deckel	09	16	CARS6430	132,00			
protection carter alternateur / Lichtmaschine Deckel	09	16	CARS6440	114,50			
protection cadre / Rahmen Abdeckung	09	16	CARS6450	220,80			
protection bras oscillant / Schwingen Abdeckung	09	16	CARS6460	196,80			
<b>GSX-R 1000 / R</b>							
garde boue avant / Vordere kotflügel	17	22	CARS6510	292,60	CARS6510M		292,60
garde boue arrière / Hintere kotflügel	17	22	CARS6521	176,40	CARS6521M		187,20
protection carter embrayage / Kupplungs - Deckel	17	22	CARS6530	135,60	CARS6530M		151,20
protection carter alternateur / Lichtmaschine Deckel	17	22	CARS6540	114,50	CARS6540M		122,40
protection cadre / Rahmen Abdeckung	17	22	CARS6550	228,00	CARS6550M		252,00
protection bras oscillant / Schwingen Abdeckung	17	22	CARS6560	208,60	CARS6560M		234,00
couvre chaîne / Kette Abdeckung	17	22	CARS6512	124,80	CARS6512M		139,20
protection de réservoir / Tankdeckel	17	22	CARS6529	327,60	CARS6529M		327,60
tubes air box racing / racing Airbox Rohre	17	22	CARS6519	324,00			

SUZUKI





Modèle - Modell	Année - Jahr		Code - Code	€	Code - Code	€
	du - von	au - bis	BRILLANTE-GLÄNZEND		OPAQUE-MATT	
<b>MT-09 / MT 09-Tracer</b>						
garde boue avant / Vordere kotflügel	13	22	CARY8910	<b>276,00</b>		
garde boue arrière / Hintere kotflügel	13	22	CARY8920	<b>175,20</b>		
<b>MT-10</b>						
garde boue avant / Vordere kotflügel	16	21	CARY5010	<b>276,00</b>		
garde boue arrière / Hintere kotflügel	16	21	CARY5020	<b>201,60</b>		
couvre chaîne / Kette Abdeckung	16	21	CARY5012	<b>89,00</b>		
protection carter embrayage / Kupplungs - Deckel	16	21	CARY5130	<b>148,80</b>		
protection carter alternateur / Lichtmaschine Deckel	16	21	CARY5140	<b>124,80</b>		
couvre pick up / pick up Deckel	16	21	CARY5018	<b>91,20</b>		
protection cadre / Rahmen Abdeckung	16	21	CARY5050	<b>228,00</b>		
protection bras oscillant / Schwingen Abdeckung	16	21	CARY5060	<b>208,60</b>		
<b>R1</b>						
garde boue avant / Vordere kotflügel	15	20	CARY5010	<b>276,00</b>		
garde boue arrière / Hintere kotflügel	15	20	CARY5020	<b>201,60</b>		
couvre chaîne / Kette Abdeckung	15	20	CARY5012	<b>89,00</b>		
protection carter embrayage / Kupplungs - Deckel	15	16	CARY5030	<b>148,80</b>		
protection carter embrayage / Kupplungs - Deckel	17	19	CARY5130	<b>148,80</b>		
protection carter alternateur / Lichtmaschine Deckel	15	20	CARY5040	<b>124,80</b>		
couvre pick up / pick up Deckel	15	20	CARY5018	<b>91,20</b>		
protection cadre / Rahmen Abdeckung	15	20	CARY5050	<b>228,00</b>		
protection bras oscillant / Schwingen Abdeckung	15	20	CARY5060	<b>208,60</b>		
panneaux sous réservoir / Tankschutz (unten)	15	19	CARY5080	<b>242,40</b>		
protection de réservoir / Tankdeckel	15	19	CARY5029	<b>314,40</b>		
<b>R1</b>						
garde boue avant / Vordere kotflügel	20	22	CARY5010	<b>276,00</b>		
garde boue arrière / Hintere kotflügel	20	22	CARY5020	<b>201,60</b>		
couvre chaîne / Kette Abdeckung	20	22	CARY5012	<b>89,00</b>		
protection carter embrayage / Kupplungs - Deckel	20	22	CARY5130	<b>148,80</b>		
protection carter alternateur / Lichtmaschine Deckel	20	22	CARY5040	<b>124,80</b>		
couvre pick up / pick up Deckel	20	22	CARY5018	<b>91,20</b>		
protection cadre / Rahmen Abdeckung	20	22	CARY5050	<b>228,00</b>		
protection bras oscillant / Schwingen Abdeckung	20	22	CARY5060	<b>208,60</b>		
<b>R1-M</b>						
garde boue avant / Vordere kotflügel	20	22	CARY5110	<b>288,00</b>		
garde boue arrière / Hintere kotflügel	20	22	CARY5020	<b>201,60</b>		
couvre chaîne / Kette Abdeckung	20	22	CARY5012	<b>89,00</b>		
protection de réservoir / Tankdeckel	20	22	CARY5129	<b>326,40</b>		
protection carter embrayage / Kupplungs - Deckel	20	22	CARY5130	<b>148,80</b>		
protection carter alternateur / Lichtmaschine Deckel	20	22	CARY5040	<b>124,80</b>		
couvre pick up / pick up Deckel	20	22	CARY5018	<b>91,20</b>		
protection cadre / Rahmen Abdeckung	20	22	CARY5050	<b>228,00</b>		
protection bras oscillant / Schwingen Abdeckung	20	22	CARY5060	<b>208,60</b>		
protection de réservoir / Tankschutz	20	22	CARY5190	<b>120,00</b>		

FINE DE LA SÉRIE - AUSLAUFARTIKEL

Modèle - Modell	Année - Jahr		Code - Code	€	Code - Code		€
	du - von	au - bis	BRILLANTE-GLÄNZEND		OPAQUE-MATT		
<b>YZF R6</b>							
garde boue avant / Vordere kotflügel	06	16	CARY9910	<b>184,80</b>			
garde boue arrière / Hintere kotflügel	06	16	CARY9920	<b>163,20</b>			
protection carter embrayage / Kupplungs - Deckel	06	16	CARY9930	<b>120,00</b>			
protection carter alternateur / Lichtmaschine Deckel	06	16	CARY9940	<b>108,00</b>			
couvre pick up / pick up Deckel	06	16	CARY9918	<b>91,20</b>			
protection cadre / Rahmen Abdeckung	06	16	CARY9950	<b>208,80</b>			
protection bras oscillant / Schwingen Abdeckung	06	16	CARY9960	<b>196,80</b>			

<b>YZF R6</b>							
garde boue avant / Vordere kotflügel	17	22	CARY5010	<b>276,00</b>			
couvre chaîne / Kette Abdeckung	17	22	CARY9912	<b>112,80</b>			
garde boue arrière / Hintere kotflügel	17	22	CARY9920	<b>163,20</b>			
protection carter embrayage / Kupplungs - Deckel	17	22	CARY9930	<b>120,00</b>			
protection carter alternateur / Lichtmaschine Deckel	17	22	CARY9940	<b>108,00</b>			
couvre pick up / pick up Deckel	17	22	CARY9918	<b>91,20</b>			
protection cadre / Rahmen Abdeckung	17	22	CARY9951	<b>220,80</b>			
protection bras oscillant / Schwingen Abdeckung	17	22	CARY9961	<b>196,80</b>			
protection de réservoir / Tankdeckel	17	22	CARY9929	<b>314,40</b>			
protection de réservoir / Tankschutz	17	22	CARY9990	<b>132,00</b>			

YAMAHA

NEW!

<b>YZF R7</b>							
garde boue avant / Vordere kotflügel	22	22	CARY0710	<b>xxx</b>			
garde boue arrière / Hintere kotflügel	22	22	CARY0720	<b>xxx</b>			
protection carter embrayage / Kupplungs - Deckel	22	22		<b>xxx</b>			
protection carter alternateur / Lichtmaschine Deckel	22	22		<b>xxx</b>			
couvre pick up / pick up Deckel	22	22		<b>xxx</b>			
protection cadre / Rahmen Abdeckung	22	22	CARY0750	<b>xxx</b>			
protection bras oscillant / Schwingen Abdeckung	22	22	CARY0760	<b>xxx</b>			

<b>T-MAX 500 / 530</b>							
garde boue avant / Vordere kotflügel	08	14	CARY4610	<b>196,80</b>	CARY4610M	<b>196,80</b>	
garde boue avant / Vordere kotflügel	15	16	CARY4710	<b>196,80</b>	CARY4710M	<b>196,80</b>	
protection bras oscillant / Schwingen Abdeckung	12	16	CARY4660	<b>152,60</b>	CARY4660M	<b>165,40</b>	
couvre ceinture / Kettenschutz	12	16	CARY4612	<b>114,50</b>	CARY4612M	<b>122,40</b>	

<b>T-MAX 530 / 560</b>							
couvre ceinture supérieure / Oberer Kettenschutz	17	21	CARY4912	<b>192,00</b>	CARY4914M	<b>192,00</b>	
couvre ceinture inférieur / Unterer Kettenschutz	17	21	CARY4914	<b>182,40</b>	CARY4914M	<b>182,40</b>	

<b>RACING</b>							
Pinne protection chaîne / Kettenabdeckung			CAR001	<b>60,00</b>			
Convoyeurs à air pour étriers de frein / Bremssattelförderer			CAR007	<b>192,00</b>			

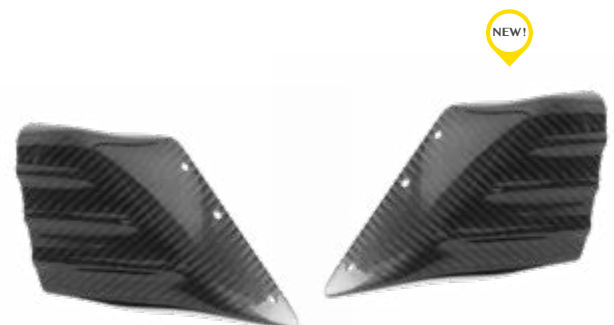



**BÉQUILLES  
MOTORRADSTÄNDER**

---

**RACING & BOX**



## BÉQUILLE ARRIÈRE EN CARBONE

206 CARBONSTÄNDER



kg 2,1

Couleurs disponibles: noir  
Verfügbare Farben: schwarz

Béquille arrière en carbone avec fourches  
Hinterrad: Carbonständer mit Gabelaufnahme

RSC001F

Béquille arrière en carbone avec roulements  
Hinterrad: Carbonständer mit Rollen

RSC001R

Béquille avant en carbone sous plaque  
Vorderrad: Carbonständer unter Platte

RSC002







 kg 4,0

Béquille avant en acier inoxydable  
Vorderer Ständer aus Edelstahl

RSS001 € 282,00

Goujon en acier inoxydable pour bequille / Bolzen für Ständer aus Edelstahl



**NEW!**

Modèle - Modell	Ø	Code - Code	€
RSS00	12,7	PIN001	<b>7,90</b>
RSS001 - BMW S1000RR	15,7	PIN002	<b>7,90</b>
RSS001 - Aprilia RSV4	19,8	PIN003	<b>7,90</b>
RSS001 - Kawasaki Ninja 400	22,0	PIN004	<b>7,90</b>
RSS001	24,0	PIN005	<b>7,90</b>
RSS001 - Kawasaki ZX10R / ZX6R / Z900	27,7	PIN006	<b>7,90</b>
RSS001 - Yamaha R1 / R6	16,5	PIN007	<b>7,90</b>
RSS001 - Yamaha R3	17,2	PIN008	<b>7,90</b>
RSS001 - Suzuki GSXR1000	15,9	PIN009	<b>7,90</b>
RSS001 - Yamaha R7	20,1	PIN010	<b>7,90</b>

## BÉQUILLE EN MÉTAL

208 METALLSSTÄNDER



 kg 2,3

Béquille avant en fer  
Vorderrad: Ständer aus Stahl

RSF008 € 61,80



 kg 3,2

Béquille avant en acier, avec levage sous les étriers de frein.  
Vorderradständer mit Halterung unter dem Bremssattel

RSF042 € 112,20



RSA23F

RSF042



 **kg 3,0**

Béquille arrière 2 roues avec fourchettes en fer  
Hinterrad: Ständer aus Stahl mit Gabelaufnahme (2 Rad)

RSF036 € 49,80



 **kg 3,1**

Béquille arrière 2 roues avec fourchettes en fer  
Hinterrad: Ständer aus Stahl mit Gabelaufnahme (2 Rad)



RSF045F € 77,80

Béquille arrière 2 roues avec patines en fer  
Hinterrad: Ständer aus Stahl mit Gleitbackenaufnahme (2 Rad)



RSF045P € 89,30

Béquille arrière 2 roues avec roulements en fer  
Hinterrad: Ständer aus Stahl mit Rollen (2 Rad)



RSF045R € 100,80



 **kg 2,9**

Béquille avant en fer  
Vorderrad: Ständer aus Stahl

RSF22 € 109,30



 **kg 4,5**

Béquille arrière en fer avec fourchettes  
Hinterrad: Ständer aus Stahl mit Gabelaufnahme



RSF21F € 124,70

Béquille arrière en fer avec patines  
Hinterrad: Ständer aus Stahl mit Gleitbackenaufnahme



RSF21P € 137,40

Béquille arrière en fer avec roulements  
Hinterrad: Ständer aus Stahl mit Rolle



RSF21R € 150,00

# BÉQUILLE EN MÉTAL

210 METALLSTÄNDER



kg 5,1

Béquille postérieur mono-bras en fer (sans goujon)  
Einarmständer hinten aus Stahl (ohne Bolzen)

RSF046 € 190,60

Goujon pour bequille mono-bras en fer / Bolzen für Monoarmig Einarmständer aus Eisen

ø perno - ø pin	Code - Code	€
42,7	RSF26	29,20
28,4	RSF27	29,20
26,8	RSF28	29,20
40,6	RSF29	29,20
25,7	RSF30	29,20
53,5	RSF37	29,20
18,0	RSF38	29,20
27,7	RSF39	29,20

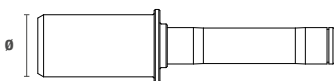

Liste d'application des goujons pour bequille mono-bras  
Bolzen-Anwendungsliste für Einarmständer

Modèle - Modell	Ø	Code - Code
<b>BMW</b>		
R 1200 GS (2003 - 2012) pin. DX	53,5	RSF37
R 1200 GS (2013 - 2017) pin. SX	53,5	RSF37
R Nine T	53,5	RSF37
<b>DUCATI</b>		
848 / 848 EVO / 748	25,7	RSF30
1098 / 1198	40,6	RSF29
Panigale 1199 / 1299 / V4 / V2	40,6	RSF29
996 / 998	25,7	RSF30
S2R / S4R	25,7	RSF30
Monster 796	25,7	RSF30
Monster 1100	25,7	RSF30
Monster 1200 / 1200R	40,6	RSF29
Multistrada 1100	25,7	RSF30
Multistrada 1200	40,6	RSF29
Hypermotard 796/1100/821/939/959/950	25,7	RSF30
Streetfighter 848 / 1100	25,7	RSF30
Streetfighter 1098 S	40,6	RSF29
Streetfighter V4 / S	40,6	RSF29
Diavel	40,6	RSF29
<b>HONDA</b>		
CB 1000 R (2008 - 2017)	28,4	RSF27
CB 1000 R (2018 - 2020)	18,0	RSF38
VFR 800	28,4	RSF27
<b>KTM</b>		
Superduke 1290 R	27,7	RSF39
<b>MV</b>		
Brutale	42,7	RSF26
F4 / F3	42,7	RSF26
<b>TRIUMPH</b>		
Speed Triple 1050	26,8	RSF28
Speed Triple RS 1200	40,6	RSF29





kg 3,5

Béquille arrière modulaire 4 roues en fer  
Hinterrad: Modular Ständer aus Stahl mit Gabelaufnahme (4 Rad)

RSF038 € 76,10



kg 3,6



Béquille arrière modulaire 4 roues avec fourchettes en fer  
Hinterrad: Modular Ständer aus Stahl mit Gabelaufnahme (4 Rad)



RSF039F € 83,60

Béquille arrière modulaire 4 roues avec patines en fer  
Hinterrad: Modular Ständer aus Stahl mit Gleitbackenaufnahme (2 Rad)



RSF039P € 95,00

Béquille arrière modulaire 4 roues avec roulements en fer  
Hinterrad: Modular Ständer aus Stahl mit Rollen (4 Rad)



RSF039R € 107,60

PIÈCE DE RECHANGE POUR BÉQUILLES  
ERSATZTEILE FÜR STÄNDER



Fourchettes  
Gabelaufnahme

RSF23 € 17,70

pour la paire - 1 Paar



Patines  
Gleitbackenaufnahme

RSF24 € 24,10

pour la paire - 1 Paar



Roulements  
Rollen

RSF25 € 29,80

pour la paire - 1 Paar



Roues  
Räder

RW001 € 17,70

pour la paire - 1 Paar



kg xxx - Dimension: L1340 x P450 H 1400

Chariot porte jantes en acier inoxydable  
Felgenständer aus Edelstahl

RSS004 € 696,00



kg 14,00 - Dimension: L1440 x P500 H 1300

Rack jantes en aluminium avec 10 emplacement  
Aluminium Felgenständer mit 10 Plätzen

RSA14 € 510,60

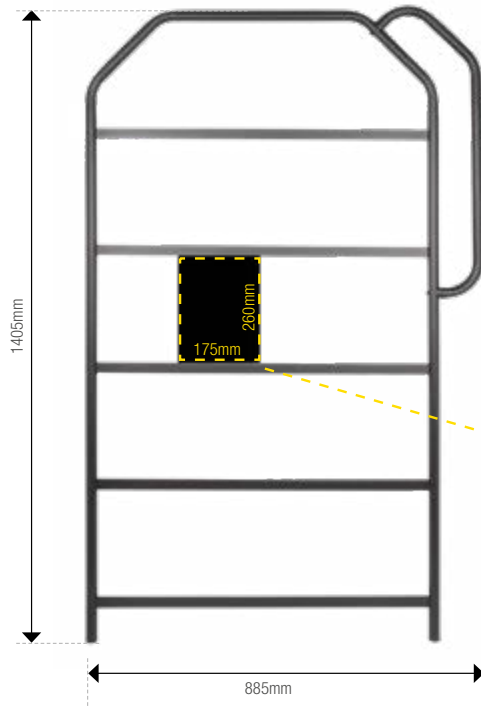

kg 2,2

Aluminium pitboard peint en noir  
Pitboard aus Aluminium, schwarz lackiert

TTG004 € 320,50

avec 50 tableaux sans lettres et des chiffres  
Tafel mit 50 Plätzen ohne Schriftzeichen und Zahlen

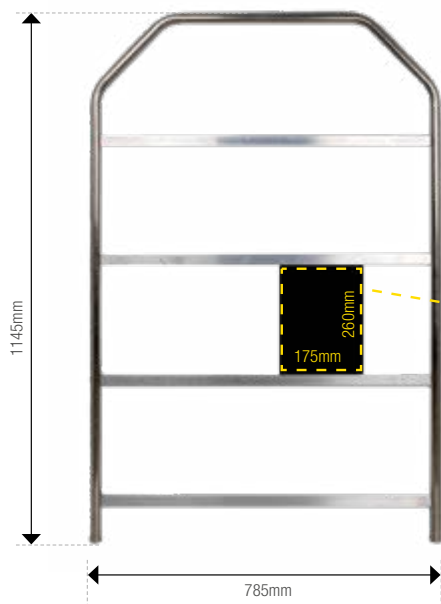

kg 1,5

Aluminium pitboard - Alu naturel  
Pitboard aus Aluminium, nicht lackiert

TTG005 € 196,90

avec 36 tableaux sans lettres et des chiffres  
Tafel mit 36 Plätzen ohne Schriftzeichen und Zahlen



Échéancier en PVC (minimum requis 10 pièces).  
Tafel aus PVC ( Mindestbestellmenge 10 St.)

TTG004-08 € 3,00

**1234567890**

3 autocollants pour chaque numéro  
3 Aufkleber für jede Zahl

+

**BOXLP + - →**

1 autocollant pour chaque lettre/symbole  
1 Aufkleber für jede Buchstaben/Symbol

# SLIDERS

214 KNIESCHLEIFER

NEW!



## Aeroslider

SAP002 € 26,40

Couleurs disponible: blanc, noir  
Verfügbare Weiss, Schwarz

pour la paire/1 Paar



## Rain

SAPR001 € 41,80

Couleurs disponible: rouge / Verfügbare Farben: Rot

pour la paire/1 Paar



pièce de rechange / Ersatzteile

RSAPR001 € 9,10

a pièce - 1 Stück



## Filler

SAPF € 24,10

Couleurs disponible: rouge, jaune / Verfügbare Farben: Rot, Gelb

pour la paire/1 Paar



## Nuke

SAPN € 30,90

Couleurs disponible: noir  
Verfügbare Farben: Schwarz

pour la paire/1 Paar



## Dropper

SAPDRO € 24,10

Couleurs disponible: rouge, bleu, blanc, noir, jaune  
Verfügbare Farben: Rot, Blau, Weiss, Schwarz, Gelb

pour la paire/1 Paar



## Leather

SAPL € 47,60

Cuir / Leder

pour la paire/1 Paar





**ADHÉSIFS**  
TANKPAD/  
FELGENRANDAUFKLEBER

# PROTEGE RESERVOIR

216 TANKAUFKLEBER



L130 x H190

Protection de réservoir transparent  
Transparenter Tankschutzaufkleber

STK123

€ 15,60

FLAG ITALIA - ITALY FLAG

1 piece  
1 Stück



L130 x H190

Protection de réservoir noir  
Schwarzer Tankschutzaufkleber

STK124

€ 15,60

FLAG ITALIA - ITALY FLAG

1 piece  
1 Stück



L130 x H190

Protection de réservoir à texture de carbone  
Carbon Texture Tankschutzaufkleber

STK126

€ 15,60

FLAG ITALIA - ITALY FLAG

1 piece  
1 Stück



L130 x H190

Protection de réservoir noir  
Schwarzer Tankschutzaufkleber

STK125

€ 15,60

FLAG ITALIA - ITALY FLAG

1 piece  
1 Stück





L130 x H190

Protection de réservoir noir  
Schwarzer Tankschutzaufkleber

STK089

€ 18,60

FLAG ITALIA - ITALY FLAG

1 piece  
1 Stück



L130 x H190

Protection de réservoir transparent  
Transparenter Tankschutzaufkleber

STK090

€ 15,60

1 piece  
1 Stück



L130 x H190

Protection de réservoir fumé  
Rauchschutzaufkleber

STK091

€ 15,60

1 piece  
1 Stück



L130 x H190

Protection de réservoir noir métallique  
Metallischer schwarzer Tankschutzaufkleber

STK092

€ 15,60

1 piece  
1 Stück



L130 x H190

Protection de réservoir à texture de carbone  
Carbon Texture Tankschutzaufkleber

STK093

€ 15,60

1 piece  
1 Stück



L130 x H190

Protection de réservoir à texture de carbone  
Carbon Texture Tankschutzaufkleber

STK113

€ 15,60

CUSTOM LIGHTTECH

1 piece  
1 Stück





L115 x H210

Protection de réservoir slim  
Tankschutzaufkleber slim

STK094

€ 13,90

TRANSPARENT

1 piece  
1 Stück



L115 x H210

Protection de réservoir slim  
Tankschutzaufkleber slim

STK095

€ 13,90

METALLIC BLACK

1 piece  
1 Stück



L115 x H210

Protection de réservoir slim  
Tankschutzaufkleber slim

STK096

€ 13,90

CARBON TEXTURE

1 piece  
1 Stück



L115 x H215

Protection de réservoir flat  
Tankschutzaufkleber flat

STK097

€ 8,50

CARBON TEXTURE

1 piece  
1 Stück



L130 x H185

Protection de réservoir full  
Tankschutzaufkleber full

STK098

€ 22,80

CARBON TEXTURE

1 piece  
1 Stück



L105 x H175

Protection de réservoir en fibre de carbone  
Kohlefasertankschutzaufkleber

STK121

€ 58,00

CARBON TEXTURE

1 piece  
1 Stück



L85 x H146

Protection de réservoir mini  
Tankschutzaufkleber mini

STK099

€ 13,90

TRANSPARENT

1 piece  
1 Stück



L85 x H146

Protection de réservoir mini  
Tankschutzaufkleber mini

STK100

€ 13,90

METALLIC BLACK

1 piece  
1 Stück



L85 x H146

Protection de réservoir mini  
Tankschutzaufkleber mini

STK101

€ 13,90

CARBON TEXTURE

1 piece  
1 Stück





L110 x H205

Protection de réservoir double  
Doppeltankschutzaufkleber

STK102

€ 14,10

TRANSPARENT

1 piece  
1 Stück



L110 x H205

Protection de réservoir double  
Doppeltankschutzaufkleber

STK103

€ 14,10

METALLIC BLACK

1 piece  
1 Stück



L110 x H205

Protection de réservoir double  
Doppeltankschutzaufkleber

STK104

€ 14,10

CARBON TEXTURE

1 piece  
1 Stück



L115 x H165

Protection de réservoir slim short  
Tankschutzaufkleber slim short

STK105

€ 13,90

TRANSPARENT

1 piece  
1 Stück



L115 x H165

Protection de réservoir slim short  
Tankschutzaufkleber slim short

STK106

€ 13,90

METALLIC BLACK

1 piece  
1 Stück



L115 x H165

Protection de réservoir slim short  
Tankschutzaufkleber slim short

STK107

€ 13,90

CARBON TEXTURE

1 piece  
1 Stück



L135 x H170

Protection de réservoir central  
Zentraler Tankschutzaufkleber

STK112

€ 8,50

Faible épaisseur 0,3 mm - Geringe Dicke 0,3 mm

1 piece  
1 Stück



L135 x H170

Protection de réservoir central  
Zentraler Tankschutzaufkleber

STK111

€ 8,50

Faible épaisseur 0,3 mm - Geringe Dicke 0,3 mm

1 piece  
1 Stück

# PROTEGE RESERVOIR

220 TANKAUFKLEBER

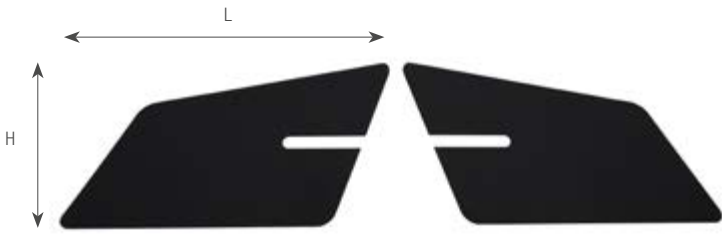

L210 x H114

STK114

€ 25,40

Kits adhésifs pour protection réservoir (latérales) 0.3 mm d'épaisseur  
Kit Tankschutzaufkleber (seitlich), Dicke 0,3 mm

pour kit / kit



L210 x H114

STK115

€ 25,40

Kits adhésifs pour protection réservoir (latérales) 0.3 mm d'épaisseur  
Kit Tankschutzaufkleber (seitlich), Dicke 0,3 mm

pour kit / kit



25 x 60 mm

STK116

€ 7,20

3M velcro double-face  
doppelklebendes Klettband 3M

pour kit / kit



20 x 60 mm

STK117

€ 12,40

3M velcro double-face  
doppelklebendes Klettband 3M

pour kit / kit

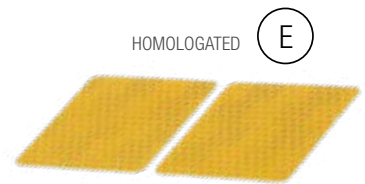

50 x 50 mm

STK120

€ 8,00

pour kit / kit

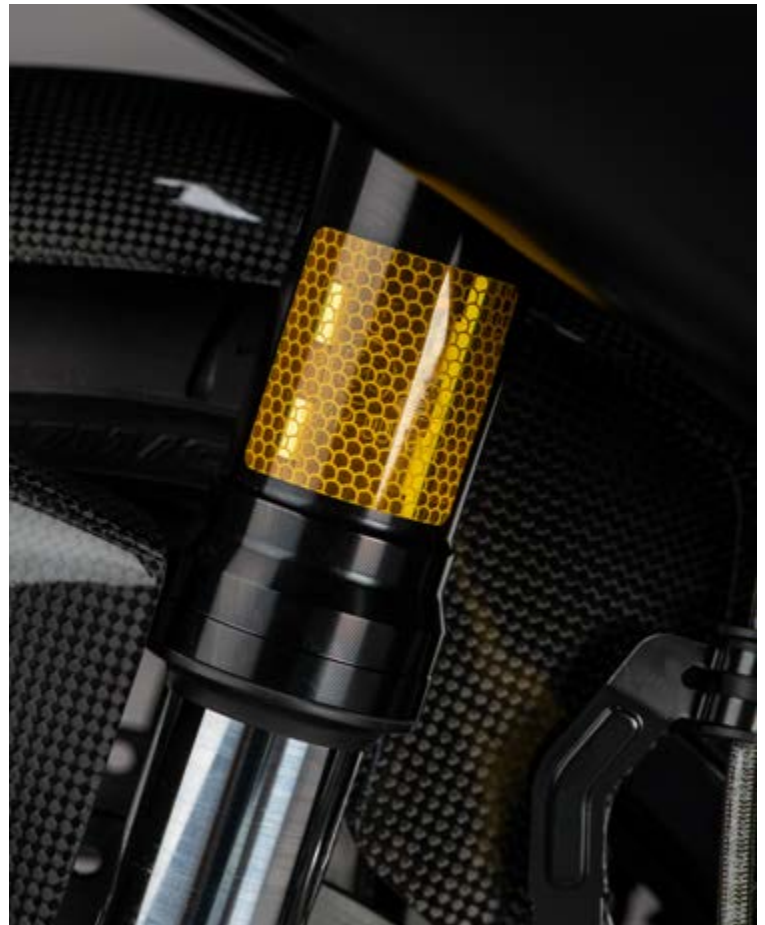



L 7000x7mm



white race



blue race



yellow race



red race



green race



orange race



orange ktm

			1 piece 1 Stück
Liserets jantes - Felgenrandaufkleber	white race	STK047	€ 11,20
Liserets jantes - Felgenrandaufkleber	blue race	STK048	€ 11,20
Liserets jantes - Felgenrandaufkleber	yellow race	STK049	€ 11,20
Liserets jantes - Felgenrandaufkleber	red race	STK050	€ 11,20
Liserets jantes - Felgenrandaufkleber	green race	STK051	€ 11,20
Liserets jantes - Felgenrandaufkleber	orange race	STK052	€ 11,20
Liserets jantes - Felgenrandaufkleber	orange ktm	STK088	€ 11,20



STK118 € 24,60

Liserets jantes - Felgenrandaufkleber

1 piece  
1 Stück



STK119 € 24,60

Liserets jantes - Felgenrandaufkleber

1 piece  
1 Stück

## ADHÉSIFS

222 AUFKLEBER



L330 x H480

STK108

€ 12,10

Film de protection transparent  
durchsichtige Schutzfolie

1 pièce  
1 Stück



L350 x H500

STK109

€ 18,60

Protection haute température (avec adhésif)  
Schutz für hohe Temperaturen (mit Aufkleber)

1 pièce  
1 Stück



L350 x H500

STK110

€ 13,40

Film à texture de carbone  
Carbon Folie

1 pièce  
1 Stück



330 x 330 x 15 mm

NSR01

€ 16,00

Neoprene pour selle racing  
Neopren für Sitzbank

a pièce - 1 Stück

## COMMUNICATION ET MERCHANDISING

WERBEMITTEL UND MERCHANDISING



Expositeur de terre · 65x200 cm  
Boden display - 65x200 cm

EXP008

€ 190,10





**APPAREL**  
by Lightech

## APPAREL

224 BY LIGHTECH



T-Shirt

€ 34,30

### TAILLES DISPONIBLES / VERFÜGBARE GRÖSSEN

	Code / Code
<b>XXS</b>	TSH001
<b>XS</b>	TSH002
<b>S</b>	TSH003
<b>M</b>	TSH004
<b>L</b>	TSH005
<b>XL</b>	TSH006
<b>XXL</b>	TSH007
<b>XXXL</b>	TSH008



Sweat à capuche / Kapuzen Sweat-shirt

€ 68,70

### TAILLES DISPONIBLES / VERFÜGBARE GRÖSSEN

	Code / Code
<b>XXS</b>	HDS001
<b>XS</b>	HDS002
<b>S</b>	HDS003
<b>M</b>	HDS004
<b>L</b>	HDS005
<b>XL</b>	HDS006
<b>XXL</b>	HDS007
<b>XXXL</b>	HDS008



Chapeau de paddock / Paddockcap BSC001 € 32,10









A close-up, low-angle photograph of the front section of a Yamaha T-MAX 560 scooter. The image focuses on the handlebar, front fairing, and headlight area. The scooter is primarily black with prominent yellow accents on the headlight cover and the handgrip. The background is a dark, neutral grey. In the upper right corner, there is a black rectangular box containing the text 'YAHAMA' and 'T-MAX 560' in white.

**YAHAMA**  
T-MAX 560



SPEY08

FBC15

LEVD014

WAPYA409

ECPYA010



FTP022 (Adaptor)

FTP100 (Footpeg)



CARY4912 (SHINE)  
CARY4912M (MATT)

CARY4914 (SHINE)  
CARY4914M (MATT)



WAPYA409

ISS114LA (left)  
ISS120RA (right)

OIL004

FTP022 (Adaptor)  
FTP100 (Footpeg)

STEYA109

KTARYA124

CARY4912 (SHINE)  
CARY4912M (MATT)

TEYA001

CARY4914 (SHINE)  
CARY4914M (MATT)





ARTICLE / ARTIKEL	DESCRIPTION / BESCHREIBUNG	année / Jahr		code / code	€
Commandes réculées / Fussrastenanlagen	repose pieds passager / Fussrasten für Beifahrer	08	22	FTP022	<b>33,20</b>
	adaptateurs pour repose pieds / Adapter für Rasten	08	22	FTP100	<b>57,20</b>
Tendeur de chaîne / Kettenspanner	tendeur / Kettenspanner	08	22	TEYA001	<b>212,90</b>
Kit levier / Kit Klappbare	kit levier de frein et d'embrayage / Kit Klappbare Brems und Kupplungshebel	08	22	KLEV116J	<b>190,00</b>
	kit levier de frein et d'embrayage "Alien" / Kit Klappbare Brems und Kupplungshebel "Alien"	08	22	KLEV116K	<b>207,20</b>
Leviers de stationnement / Parken-hebel	leviers de stationnement / Parken-hebel	08	22	LEVD014	<b>67,50</b>
Protection leviers Hebelprotector	protection du levier de frein droit en aluminium / Rechter Bremshebelschutz aus Aluminium	22	22	ISS120RA	<b>121,30</b>
	protection du levier de frein gauche en aluminium / Linker Bremshebelschutz aus Aluminium	08	22	ISS114LA	<b>121,30</b>
	adaptateur de protection de levier / Hebelschutzadapter	08	22	KPL310	<b>27,50</b>
Embouts de guidon Strukturierte Lenkergewichte		08	22	KTM410	<b>27,50</b>
	Devil series	08	22	KTM310	<b>41,80</b>
		08	22	KTM210	<b>37,80</b>
Rétroviseurs / Spiegel	Paire de rétroviseurs, fixation sur guidon / Spiegelpaar, am Lenker befestigt	08	22	SPEAL015	<b>237,00</b>
	Paire de rétroviseurs, fixation sur carénage / Spiegelpaar, Befestigung an der Verkleidung	08	22	SPEAL019	<b>317,10</b>
Couvre rétroviseur / Spiegel Abdeckung	couvre rétroviseur / Spiegel Abdeckung	08	22	SPEY08	<b>56,10</b>
Support de plaque / Kennzeichenhalter	kit supporte de plaque (T-Max 530 / 560) / Kit Kennzeichenhalter (T-Max 530 / 560)	08	22	KTARYA124	<b>105,30</b>
	kit supporte de plaque / Kit Kennzeichenhalter	12	16	KTARYA114	<b>105,30</b>
T - Max 500 (with undertail)		08	11	KTARYA112	<b>133,90</b>
T - Max 500 (without undertail)		08	11	KTARYA113	<b>105,30</b>
Protection axe de roue / Radachse Protpektoren	kit protection axe de roue / Kit Radachse Protpektoren	15	21	WAPYA409	<b>77,80</b>
Bouchons d'huile / Ölverschlusschraube		14	21	OIL004	<b>22,90</b>
Cache bocal liquide de frein et embrayage / Bremspumpen und Kupplungsdeckel	frein / Brems	08	21	FBC15	<b>33,20</b>
Protection carter / Carter Abdeckung		17	21	ECPYA010	<b>219,80</b>
Couvre axe de bras oscillant / Schwingen Abdeckung		12	21	STEYA109	<b>89,30</b>
Echappement Auspuffendstück		08	16	TEX001	<b>37,80</b>
Entretoises selle Sitzerhöhungsadapter		08	16	TSR001	<b>30,90</b>
Protection talon / Fersenschutz		12	16	STEYA110	<b>45,20</b>
Carbone brillante Glänzende Carbonteile	couvre ceinture supérieure / Oberer Kettenschutz	17	21	CARY4912	<b>210,60</b>
	couvre ceinture inférieur / Unterer Kettenschutz	17	21	CARY4914	<b>198,10</b>
	garde boue avant / Vordere kotflügel	12	14	CARY4610	<b>192,30</b>
	garde boue avant / Vordere kotflügel	15	16	CARY4710	<b>192,30</b>
	protection bras oscillant / Schwingen Abdeckung	12	16	CARY4660	<b>164,90</b>
	couvre ceinture / Kettenschutz	12	16	CARY4612	<b>123,60</b>
Carbone opaque Matte Carbonteile	couvre ceinture supérieure / Oberer Kettenschutz	17	21	CARY4912M	<b>210,60</b>
	couvre ceinture inférieur / Unterer Kettenschutz	17	21	CARY4914M	<b>198,10</b>
	garde boue avant / Vordere kotflügel	12	14	CARY4610M	<b>211,60</b>
	garde boue avant / Vordere kotflügel	15	16	CARY4710M	<b>211,60</b>
	protection bras oscillant / Schwingen Abdeckung	12	16	CARY4660M	<b>178,60</b>
	couvre ceinture / Kettenschutz	12	16	CARY4612M	<b>137,40</b>





**PRIX**

Les prix indiquées sur le catalogue sont les prix de vente publics hors taxe.

**TRANSPORT**

Le transport de nos produits sera effectuées par courrier express et les frais de port seront débitée en facture.

**DÉLAIS ET MÉTHODES DE LIVRAISON**

La livraison des produits vienne normalement assurée dans 2/3 jours du réception de l'ordre pour l'Italie et prévue pour le reste du monde sur la base de la disponibilité du produit et aux besoins du client/distributeur en accord avec Lightech.

Lightech® est distribuée dans le monde entier à travers ce propre réseau de vente.

**RETOUR DE MARCHANDISE**

Dans le rare cas que le client reçoit un produit qui présent des défektivités or anomalies, le client devrait informer ,dans 5 jours ouvrables de la date de réception, le Service Clients Lightech à l'adresse e-mail sales@lightech.it pour recevoir instructions détaillées sur la modalité du possible retour du produit et relative substitution/ note de crédit.

**COMMANDE MINIMUM**

Le montant minimum de la commande doit être égal ou supérieur à 70 € net de remises et frais annexes, sauf accord contraire avec Lightech au moment de la stipulation du contrat.

**MARQUES**

Les marques suivantes registrées avec les noms: Aprilia®, BMW®, Honda®, Kawasaki®, Mv Agusta®, Suzuki®, Triumph®, Yamaha® Sont de propriété des respectives fabricants et sont ici utilisées seulement à titre descriptif.

**MIS À JOUR DU CATALOGUE**

Lightech® se réserve la faculté d'apporter des mis à jours pour d'amélioration aux produits et à leurs mis à jours d'application en toutes les moments et sans préavis.

**AVERTISSEMENTS**

Les produits Lightech® sont dessinés et réalisés pour l'utilisation en domaine compétitif. Lightech® ne sarait pas responsable pour un utilisation differente et non correcte des ses produits.

**INFORMATION SUR LES PRODUITS**

Toutes les articles inclus sur le catalogue sont réalisées en alliage légère et produit en Italie dans l'usine Lightech.

Toutes les photos, les informations et les fiches techniques qui illustrent les produits et leurs caractéristiques sont de propriété exclusive Lightech srl.

**CONTROVERSE ET RESPONSABILITÉ**

Ces conditions générales de vente sont règlementées par la législation italienne. Pour toutes les controverses relatives à la validité, interprétation ou exécution la juridiction territoriale est Treviso.

**PREISE**

Die im Katalog genannten Preise sind in Euro ohne MwSt.

**TRANSPORT**

Der Transport erfolgt mit Spediteure und die Transportkosten werden in Rechnung gestellt.

**LIEFERUNGEN**

Die Lieferung der Produkte wird normalerweise innerhalb von 2/3 Tagen nach Eingang der Bestellung in Italien erfolgen, und im Rest der Welt auf der Grundlage der Verfügbarkeit des Produktes und der Bedürfnisse des Dealers in Absprache mit Lightech geplant.

Lightech® wird weltweit über ein eigenes Vertriebsnetz vertrieben.

**ZURÜCKGEGEBENE WAREN**

Für den Fall, dass der Kunde ein Produkt erhält, das Mängel oder Schäden ausweist und nicht der Bestellung entspricht, muss er den Lightech-Kundendienst innerhalb von 5 Arbeitstagen ab dem Datum des Wareneingangs unter der E-Mail-Adresse sales@lightech.it informieren, um detaillierte Anweisungen über die Produktrückgabe zu erhalten und der damit verbundenen Ersatz- / Gutschrift zu bekommen.

**MINDESTBESTELLWERT**

Der Mindestbestellbetrag muss gleich oder höher 70 € netto Warenwert und Nebenkosten betragen, sofern mit Lightech zum Zeitpunkt der Vertragsunterzeichnung nichts anderes vereinbart wurde.

**MARKEN:**

Die folgenden registrierten Markennamen: Aprilia®, BMW®, Ducati®, Honda®, Kawasaki®, Mv Agusta®, Suzuki®, Triumph®, Yamaha® sind Eigentum der jeweiligen Hersteller und werden nur als Erkennung und Identifizierung verwendet.

**ÄNDERUNGEN IM KATALOG:**

Lightech® behalt sich das Recht vor, Verbesserungen an den Produkten und deren Anwendungsaktualisierungen ohne vorherige Vorankündigung vorzunehmen.

**ZUR BEACHTUNG:**

Lightech® Produkte werden zur Verwendung im Motorradsport hergestellt. Lightech übernimmt keiner Haftung für nickt korrekten Einbau, bzw. Anbau seiner Produkte.

**INFORMATIONEN ÜBER DAS PRODUKT**

Alle im Katalog enthaltenen Artikel bestehen aus Leichtmetallen und werden in Italien in den Werken von Lightech hergestellt.

Alle Fotos, Informationen und technischen Datenblätter, die die Produkte und ihre technischen Eigenschaften betreffen, sind das ausschließliche Eigentum von Lightech srl.

**STREITIGKEITEN UND VERANTWORTUNG**

Diese Geschäftsbedingungen werden von italienischen Gesetzen geregelt. Für Streitigkeiten in Bezug auf seine Gültigkeit, Interpretierung oder Vollstreckung, ist der Gerichtshof von Treviso zuständig.









MADE IN ITALY



Ligtech srl  
Via Serenissima, 11  
31025 S. Lucia di Piave (TV)

Tel. +39 0438 453010  
Fax +39 0438 655919

info@lightech.it  
[www.lightech.it](http://www.lightech.it)



LighTech Racing



Ligtech\_official



@LighTech\_Racing